



***R-32 Standard Efficiency Air Conditioner
Direct-Drive Packaged Rooftop Unit
15-25 Ton DSC Light Commercial***

15 - 20 Ton 11 EER / 14.2 IEER

25 Ton 10 EER / 13.2 IEER



R32

* Complete warranty details available from your local distributor or manufacturer's representative or at www.daikincomfort.com



Our Perfect Package:

Harnessing energy-efficient performance, proven technology, and enhanced comfort for life.

Since becoming the first company in Japan to manufacture packaged air conditioning systems, in 1951, Daikin has supported comfortable indoor living based on the strengths and technologies that have led to the growth of the company becoming one of the world's largest manufacturers of HVAC products, systems and refrigerants.

Today, as a comprehensive global manufacturer of HVAC products and systems, the Daikin brand is committed to being recognized as a truly global and excellent company capable of continually creating new value for its customers. The company plans to pursue sustainable growth and foster business operations that consistently harmonize with the goals of improving indoor comfort.

The group philosophy of the company includes:

- » Creating new value continuously for customers
- » Developing world leading energy-saving technology
- » Being a flexible and dynamic organization
- » Allowing employees to be the driving force for the success of the company
- » Fostering an atmosphere of best practices, boldness, and innovation
- » Thinking and acting globally



Contents

2	Introduction	2
4	Nomenclature	4
5	Features and Benefits	5
	Applications	8
	Serviceability	8
9	Product Specifications	9
	Coil Dimensions	12
	AHRI Ratings	12
	Sound Data	12
13	Dimensional Data	13
14	Expanded Cooling Data	14
20	Air Flow Data	20
39	Electrical Data	39
48	Electric Heat	48
49	Wiring Diagrams	49
59	Unit Clearances	59
60	Installation	60
	Weights	60

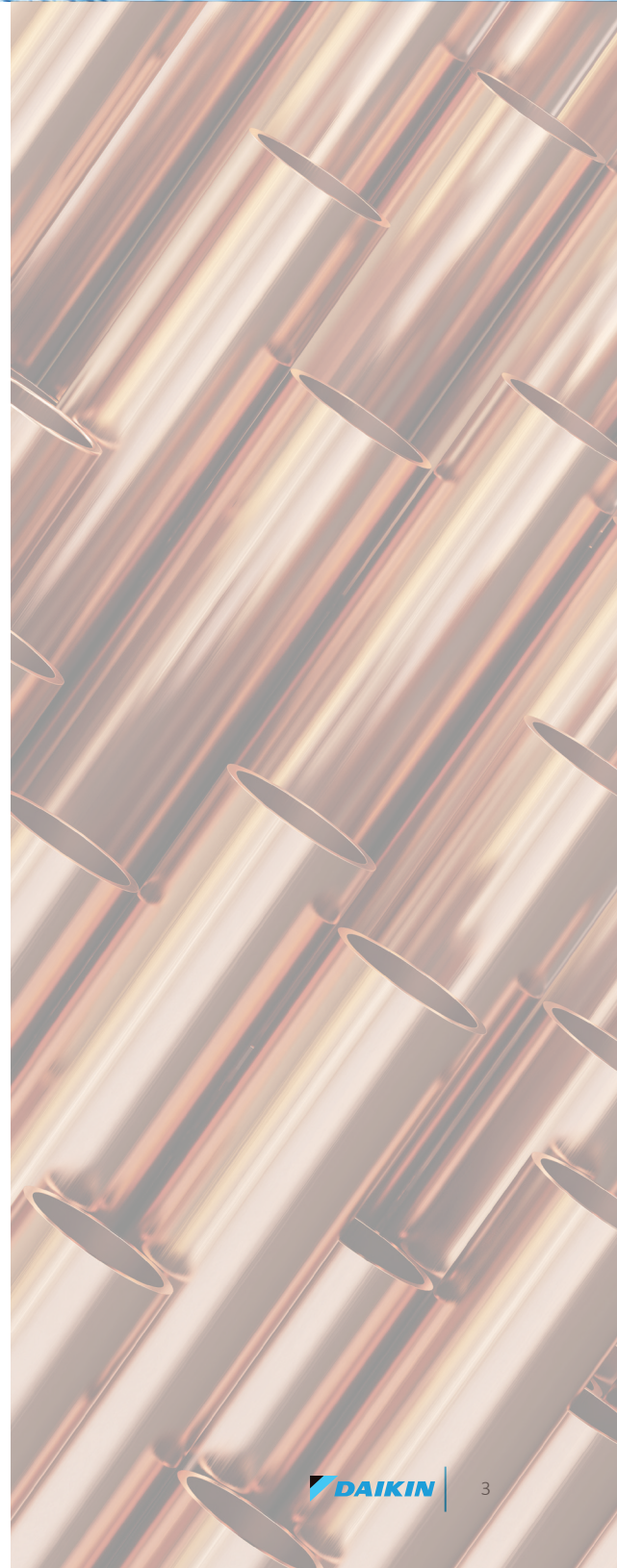

Nomenclature

	D	S	C	120	3	S	400	C	A	A	X	X	X	X	X	X	X	X	A	*																																										
	1	2	3	4,5,6	7	8	9,10,11	12	13	14	15	16	17	18	19	20	21	22	23	24																																										
Brand	D Daikin																																																													
Configuration	F Standard Efficiency R High Efficiency																																																													
Application	C Cooling G Gas Heat H Heat Pump																																																													
Nominal Cooling Capacity	036 3 Tons 090 7½ Tons 180 15 Tons 048 4 Tons 102 8½ Tons 240 20 Tons 060 5 Tons 120 10 Tons 300 25 Tons 072 6 Tons 150 12½ Tons																																																													
Voltage	1 208-230/1/60 4 460/3/60 3 208-230/3/60 7 575/3/60																																																													
Supply Fan/Drive Type/Motor	D Direct Drive - Standard Static W Direct Drive - High Static L Direct Drive -Medium Static																																																													
Nominal Heating Capacity	<table border="0"> <tr> <td>Gas/Electric</td> <td>A/C Factory-Installed Electric Heat</td> </tr> <tr> <td>045 45,000 BTU/h</td> <td>XXX No Heat</td> </tr> <tr> <td>060 60,000 BTU/h</td> <td>005 5kW</td> </tr> <tr> <td>070 70,000 BTU/h</td> <td>010 10 kW</td> </tr> <tr> <td>080 80,000 BTU/h</td> <td>015 15 kW</td> </tr> <tr> <td>090 90,000 BTU/h</td> <td>020 20 kW</td> </tr> <tr> <td>100 100,000 BTU/h</td> <td>030 30 kW</td> </tr> <tr> <td>115 115,000 BTU/h</td> <td>045 45 kW</td> </tr> <tr> <td>125 125,000 BTU/h</td> <td>060 60 kW</td> </tr> <tr> <td>130 130,000 BTU/h</td> <td>075 75kW</td> </tr> <tr> <td>140 140,000 BTU/h</td> <td></td> </tr> <tr> <td>150 150,000 BTU/h</td> <td>Electric Heat w/ SCR controls</td> </tr> <tr> <td>180 180,000 BTU/h</td> <td>S05 5kW S22 20 kW</td> </tr> <tr> <td>210 210,000 BTU/h</td> <td>S10 10 kW S25 25 kW</td> </tr> <tr> <td>225 225,000 BTU/h</td> <td>S15 15 kW S30 30 kW</td> </tr> <tr> <td>240 240,000 BTU/h</td> <td>S16 15 kW S31 30 kW</td> </tr> <tr> <td>260 260,000 BTU/h</td> <td>S18 18 kW S45 45 kW</td> </tr> <tr> <td>350 350,000 BTU/h</td> <td>S20 20 kW S46 45 kW</td> </tr> <tr> <td>360 360,000 BTU/h</td> <td>S21 20 kW S60 60 kW</td> </tr> <tr> <td>400 400,000 BTU/h</td> <td></td> </tr> <tr> <td>480 480,000 BTU/h</td> <td></td> </tr> </table>																				Gas/Electric	A/C Factory-Installed Electric Heat	045 45,000 BTU/h	XXX No Heat	060 60,000 BTU/h	005 5kW	070 70,000 BTU/h	010 10 kW	080 80,000 BTU/h	015 15 kW	090 90,000 BTU/h	020 20 kW	100 100,000 BTU/h	030 30 kW	115 115,000 BTU/h	045 45 kW	125 125,000 BTU/h	060 60 kW	130 130,000 BTU/h	075 75kW	140 140,000 BTU/h		150 150,000 BTU/h	Electric Heat w/ SCR controls	180 180,000 BTU/h	S05 5kW S22 20 kW	210 210,000 BTU/h	S10 10 kW S25 25 kW	225 225,000 BTU/h	S15 15 kW S30 30 kW	240 240,000 BTU/h	S16 15 kW S31 30 kW	260 260,000 BTU/h	S18 18 kW S45 45 kW	350 350,000 BTU/h	S20 20 kW S46 45 kW	360 360,000 BTU/h	S21 20 kW S60 60 kW	400 400,000 BTU/h		480 480,000 BTU/h	
Gas/Electric	A/C Factory-Installed Electric Heat																																																													
045 45,000 BTU/h	XXX No Heat																																																													
060 60,000 BTU/h	005 5kW																																																													
070 70,000 BTU/h	010 10 kW																																																													
080 80,000 BTU/h	015 15 kW																																																													
090 90,000 BTU/h	020 20 kW																																																													
100 100,000 BTU/h	030 30 kW																																																													
115 115,000 BTU/h	045 45 kW																																																													
125 125,000 BTU/h	060 60 kW																																																													
130 130,000 BTU/h	075 75kW																																																													
140 140,000 BTU/h																																																														
150 150,000 BTU/h	Electric Heat w/ SCR controls																																																													
180 180,000 BTU/h	S05 5kW S22 20 kW																																																													
210 210,000 BTU/h	S10 10 kW S25 25 kW																																																													
225 225,000 BTU/h	S15 15 kW S30 30 kW																																																													
240 240,000 BTU/h	S16 15 kW S31 30 kW																																																													
260 260,000 BTU/h	S18 18 kW S45 45 kW																																																													
350 350,000 BTU/h	S20 20 kW S46 45 kW																																																													
360 360,000 BTU/h	S21 20 kW S60 60 kW																																																													
400 400,000 BTU/h																																																														
480 480,000 BTU/h																																																														
Service Options	X No Options A Powered convenience outlet B Non-powered convenience outlet C Hinge Panels D Hinged Panels and Powered convenience outlet E Hinged Panels and non-powered convenience outlet																																																													
Electrical	X No Option A Non-Fused Disconnect B Phase Monitor C Non-Fused Disconnect and Phase Monitor E Thru-the-base connections E Non-Fused Disconnect and Phase Monitor F Non-Fused Disconnect and Thru-the-base connections H Phase Monitor and Thru-the-base connections L Non-Fused Disconnect, Thru-the-base connectons and Phase Monitor																																																													
Economizer	X No Options A Ultra Low-Leak Downflow Economizer w/ Enthalpy Sensor C Ultra Low-Leak Internal Horizontal Economizer w/ Enthalpy Sensor E Ultra Low-Leak Downflow Economizer for DDC controls w/ Enthalpy Sensor F Ultra Low-Leak Horizontal Economizer for DDC controls w/ Enthalpy Sensor G Ultra Low-Leak Downflow Economizer w/ Dry Bulb Sensor J Ultra Low-Leak Internal Horizontal Economizer w/ Dry Bulb Sensor L Ultra Low-Leak Downflow Economizer for DDC controls w/ Dry Bulb Sensor M Ultra Low-Leak Horizontal Economizer for DDC controls w/ Dry Bulb Sensor																																																													
Coils, Hail guard	X No Options C Hail Guard																																																													
Sensors	D R32 Sensor E RA Smoke Detector F SA Smoke Detector G RA & SA Smoke Detector																																																													

See product specifications for heat size(s) available for each capacity.

Refrigeration Systems

- A Single stage cooling modes
- C Two stage cooling modes
- F Two stage cooling modes with Hot Gas Reheat and Low-ambient control
- G Single stage cooling mode with Low-ambient controller
- H Two stage cooling mode with Low-ambient controller

Heat Exchanger

- X No options
- A Standard Aluminized Exchanger
- S Stainless Steel Exchanger
- U Ultra Low NO_x Stainless Steel Exchanger

Controls

- A Electromechanical controls
- B DDC w/ BACnet™ interface

AC STOCKING MODELS	
New Daikin 15 – 25 Ton	
MODEL NUMBER	CODE STRING
DSC1803D000001S	DSC1803DXXXXCAXXXXXXXXXXAA
DSC1804D000001S	DSC1804DXXXXCAXXXXXXXXXXAA
DSC1807D000001S	DSC1807DXXXXCAXXXXXXXXXXAA
DSC2403D000001S	DSC2403DXXXXCAXXXXXXXXXXAA
DSC2404D000001S	DSC2404DXXXXCAXXXXXXXXXXAA
DSC2407D000001S	DSC2407DXXXXCAXXXXXXXXXXAA
DSC3003D000001S	DSC3003DXXXXCAXXXXXXXXXXAA
DSC3004D000001S	DSC3004DXXXXCAXXXXXXXXXXAA
DSC3007D000001S	DSC3007DXXXXCAXXXXXXXXXXAA

Features and Benefits

Daikin Packaged Rooftop Units (RTUs) are built to perform, with features and options that help provide low installation and operation costs, superior indoor air quality, efficient operation, and longevity.

Installation

Daikin Packaged units are designed with fast and easy installation in mind and are ideal for both new construction and retrofit projects.

Cabinet Construction

Daikin packaged rooftop units are made with high quality galvanized steel with a powder-paint finish to provide higher corrosion resistance.

- » Unit fully insulated to prevent sweating and thermal losses, using our foil face fiberglass insulation which also omits exposed filter fibers into the airstream.
- » The full perimeter base rail is built using heavy gauge galvanized steel for a stronger structural installation. The base rails are a minimum of 3 ½" tall and include holes to allow for overhead rigging and lifting with forklifts.
- » Electrical lines can be brought through the base of the unit or through the horizontal knockout for easy installation and accessibility on the field

Compressor

High performance, low noise scroll compressors with stage control to match the required total load for efficient part load control.

- » Resiliently factory-mounted on rubber grommets for vibration isolation.
- » Refrigeration circuits includes both high and low pressure safety switches.
- » Unit is factory charged with environmental friendly and sustainable low GWP R-32 refrigerant.
- » Two single-stage scroll compressors individually circuited for partial load applications.
- » Compressor location outside the condenser section to avoid air bypass.
- » Crankcase heaters and external thermal overload protection are also provided for compressor durability.

Supply Fan

Supply fan will be 2 direct-drive motors. Ball bearing Direct-Drive EEM motor removes the need for belts, sheaves, bearings and lubrication.

- » Slide out forward curb fans for easy maintenance and replacement.
- » High-static drive options for applications with high airflow/ static requirements.
- » Each fan assembly is dynamically trim balanced at the factory before shipment for quick start-up and efficient operation.
- » Motor with thermal overload is provided for long lasting operation.

Coils

The indoor coil section is installed in a draw through configuration to provide better dehumidification. These coils are constructed with seamless copper tubes, mechanically bonded into aluminum plate-type fins with full drawn collars to completely cover the tubes for high operating efficiencies.

- » Coils are factory pressure tested to ensure pressure and leak integrity.
- » Coils include a Thermal Expansion Valve per circuit, high- and low pressure switches, service ports and high capacity filter drier.
- » All units use large face area outdoor coils.
- » Copper tube / aluminum fin coils on evaporator
- » Microchannel heat exchanger technology on all condenser coils for improved performance and reduced refrigerant load.



Controls and Wiring

Packaged rooftop units come equipped with a well-organized, large, easy to use, weatherproof internal control box with easy access, for a better user experience.

- » Units are factory-wired with color-coded wires and complete 24-volt Electromechanical controls package.
- » Units include single-point power entry as standard and also available with electric heat kits if selected.
- » Terminal strips are provided as standard for easy installation and field power wiring.

Filtration

Unit provides a draw-through filter section as standard for better air quality and long lasting component maintenance.

- » Filters installed on the units are standard off the shelf sizes for easy replacement.
- » 2" deep filters standard on all units with option for up to 4" on large chassis (15 tons and over).

Heating Section

Wide range of electric heat selections effectively handle most comfort heating demand from morning warm-up control to full heat.

Electric Heat

ETL approved electric heat is factory assembled, installed and tested.

- » Heating control is fully integrated into the unit's control system for quick start-up and reliable control.
- » Multi-stage capability for application flexibility.
- » Durable low watt density, nickel chromium elements provide longer life (compared to units without)..

- » Fuses are provided in each branch circuit to a maximum of 48 Amps per NEC requirements.
- » Single-point power connection reduces installation cost.
- » Operational safeties for electric heat includes automatic reset, and high temperature limit protection to prevent electric heat operation in the event of no airflow.

Electrical

Units are completely wired and tested at the factory to provide faster commissioning and start-up.

- » Wiring complies with NEC requirements and all applicable UL standards.
- » Units are factory-wired with color-coded wires and complete 24-volt electromechanical controls package.
- » A 115 V GFI convenience outlet requiring independent power supply for the receptacle is optional.
- » An optional unit powered 20 amp 115 V convenience outlet, complete with factory mounted transformer, disconnect switch, and primary and secondary overload protection, eliminates the need to pull a separate 115 V power source.
- » Supply air fan, compressor, and condenser fan motor branch circuits have individual short circuit protection. Unit includes knockouts in the bottom of the main control panels for field wiring entrance.
- » A single-point power connection with power block is standard and a terminal strip is provided for connecting low voltage control wiring.
- » For better serviceability an optional non-fused disconnect switch is mounted inside the control panel and operated by an externally mounted handle to disconnect the electrical power at the unit.

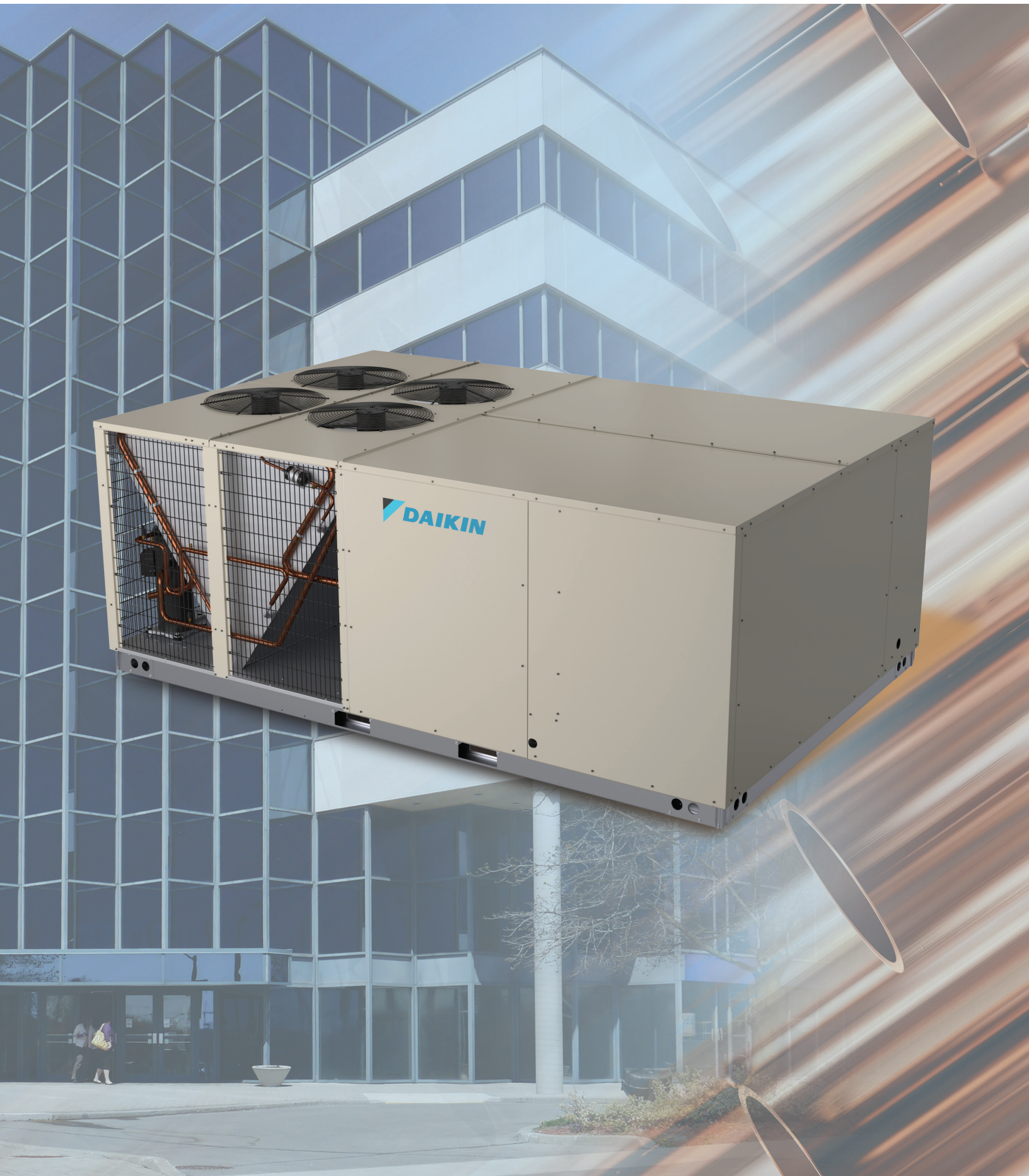

Applications

Daikin Rooftop units are intended for comfort cooling applications in normal heating, ventilating, and air conditioning. Consult your local Daikin sales representative for applications involving operations at high ambient temperatures, high altitudes, non-cataloged voltages, or for job-specific unit selections that fall outside of the range of the catalog tables.

For proper operation, units should be rigged in accordance with instructions stated on the installation manual. Fire dampers, if required, must be installed in the ductwork according to local and/or state codes. No space is allowed for these dampers in the unit.

Follow factory check, test and start procedures explicitly to achieve satisfactory start-up and operation.

Most rooftop applications take advantage of the significant energy savings provided with economizer operation. When an economizer system is used, mechanical refrigeration is typically not required below an ambient temperature of 50°F on most cases.

Serviceability

Daikin packaged rooftop units are built with serviceability in mind, designed to make future maintenance and service on the unit easy and accessible.

- » Our packaged rooftop units offer a slide out blower to facilitate the access and removal of the fan.
- » Independent compressor outside of the air bypass to eliminate component blockage and provide easy access.
- » Color coded wire to identify point-to-point component connections.
- » Condenser clean out from inside-out.
- » Easy access to control panel.



PHYSICAL DATA COOLING			
Model	DSC1803D000001S	DSC1804D000001S	DSC1807D000001S
COOLING CAPACITY			
Total BTU/H	172,000	172,000	172,000
EER	11	11	11
IEER	14.2	14.2	14.2
AHRI Reference #	215894114	215894114	215894114
EVAPORATOR MOTOR / RTPF (ROUND TUBE PLATE FIN)			
Motor Type	Direct Drive	Direct Drive	Direct Drive
External Static Pressure (ESP)	Standard	Standard	Standard
Wheel Dia. X Width	15 x 15	15 x 15	15 x 15
Indoor Nominal CFM	5000	5000	5000
RPM	300-1600	300-1600	300-1600
Indoor Horsepower	3.5	3.5	3.5
Filter Size (in)	20 X 20 X 2 (8)	20 X 20 X 2 (8)	20 X 20 X 2 (8)
Drain Size (NPT)	1"	1"	1"
R-32 Refrigerant Charge (oz.) (1)	105	105	105
R-32 Refrigerant Charge (oz.) (2)	90	90	90
Evaporator Coil Face Area (ft ²)	21.69	21.69	21.69
Rows Deep/ Fins per Inch	2/18	2/18	2/18
CONDENSER FAN / MCHX (MICROCHANNEL HEAT EXCHANGER)			
Quantity of Condenser Fan Motors	3	3	3
RPM (High/Low stage)	1122	1050	1050
Outdoor Horsepower	1/3	1/3	1/3
Fan Diameter/ # Fan Blades	22 / 3	22 / 3	22 / 3
Face Area (ft ²)	25.7	25.7	25.7
Rows Deep / Fins per Inch	1/23	1/23	1/23
COMPRESSOR			
Quantity / Type / Stages per Compression	2 / Scroll / 1	2 / Scroll / 1	2 / Scroll / 1
Compressor RLA / LRA	25.0 / 179	10.9 / 103.0	8.4 / 78.0
ELECTRICAL DATA			
Voltage-Phase-Frequency	208/230-3-60	460-3-60	575-3-60
Indoor Blower FLA	10.9	7.2	5
Max External Static (In. W.C.)	1.2	1.2	1.2
Outdoor Fan FLA	2	0.85	0.67
Min. Circuit Ampacity ¹	84.1/84.1	41.4	31
Max. Overcurrent Protection (A) ²	100/100	50	35
Power Supply Conduit Hole Dia. (in)	2.5	2.5	2.5
Low-Voltage Conduit Hole Dia. (in)	0.5	0.5	0.5
OPERATING WEIGHT (LBS.)			
	1736	1736	1736
SHIPPING WEIGHT (LBS.)			
	1851	1851	1851

¹ Wire size should be determined in accordance with National Electrical Codes. Extensive wire runs will require larger wire sizes.

² May use fuses or HACR-type circuit breakers of the same size as noted.

Note: Always check the S&R plate for electrical data on the unit being installed.

PHYSICAL DATA COOLING			
Model	DSC2403D000001S	DSC2404D000001S	DSC2407D000001S
COOLING CAPACITY			
Total BTU/H	230,000	230,000	230,000
EER	11	11	11
IEER	14.2	14.2	14.2
AHRI Reference #	215894115	215894115	215894115
EVAPORATOR MOTOR / RTPF (ROUND TUBE PLATE FIN)			
Motor Type	Direct Drive	Direct Drive	Direct Drive
External Static Pressure (ESP)	Standard	Standard	Standard
Wheel Dia. X Width	15 x 15	15 x 15	15 x 15
Indoor Nominal CFM	6400	6400	6400
RPM	300-1600	300-1600	300-1600
Indoor Horsepower	3.5	3.5	3.5
Filter Size (in)	20 X 20 X 2 (8)	20 X 20 X 2 (8)	20 X 20 X 2 (8)
Drain Size (NPT)	1"	1"	1"
R-32 Refrigerant Charge (oz.) (1)	150	150	150
R-32 Refrigerant Charge (oz.) (2)	140	140	140
Evaporator Coil Face Area (ft ²)	21.69	21.69	21.69
Rows Deep/ Fins per Inch	4/18	4/18	4/18
CONDENSER FAN / MCHX (MICROCHANNEL HEAT EXCHANGER)			
Quantity of Condenser Fan Motors	4	4	4
RPM (High/Low stage)	1130	1115	1075
Outdoor Horsepower	1/2	1/2	1/2
Fan Diameter/ # Fan Blades	22 / 3	22 / 3	22 / 3
Face Area (ft ²)	25.7	25.7	25.7
Rows Deep / Fins per Inch	1/23	1/23	1/23
COMPRESSOR			
Quantity / Type / Stages per Compression	2 / Scroll / 1	2 / Scroll / 1	2 / Scroll / 1
Compressor RLA / LRA	29.4 / 225	13.7 / 130.0	10.9 / 93.7
ELECTRICAL DATA			
Voltage-Phase-Frequency	208/230-3-60	460-3-60	575-3-60
Indoor Blower FLA	10.9	7.2	5
Max External Static (In. W.C.)	1.2	1.2	1.2
Outdoor Fan FLA	2.7	1.4	1
Min. Circuit Ampacity ¹	98.7/98.7	50.8	38.5
Max. Overcurrent Protection (A) ²	125/125	60	45
Power Supply Conduit Hole Dia. (in)	2.5	2.5	2.5
Low-Voltage Conduit Hole Dia. (in)	0.5	0.5	0.5
OPERATING WEIGHT (LBS.)			
	2089	2089	2089
SHIPPING WEIGHT (LBS.)			
	2204	2204	2204

¹ Wire size should be determined in accordance with National Electrical Codes. Extensive wire runs will require larger wire sizes.

² May use fuses or HACR-type circuit breakers of the same size as noted.

Note: Always check the S&R plate for electrical data on the unit being installed.

PHYSICAL DATA COOLING			
Model	DSC3003D000001S	DSC3004D000001S	DSC3007D000001S
COOLING CAPACITY			
Total BTU/H	290,000	290,000	290,000
EER	10	10	10
IEER	13.2	13.2	13.2
AHRI Reference #	215894120	215894120	215894120
EVAPORATOR MOTOR / RTPF (ROUND TUBE PLATE FIN)			
Motor Type	Direct Drive	Direct Drive	Direct Drive
External Static Pressure (ESP)	Standard	Standard	Standard
Wheel Dia. X Width	15 x 15	15 x 15	15 x 15
Indoor Nominal CFM	7650	7650	7650
RPM	300-1600	300-1600	300-1600
Indoor Horsepower	5	5	5
Filter Size (in)	20 X 20 X 2 (8)	20 X 20 X 2 (8)	20 X 20 X 2 (8)
Drain Size (NPT)	1"	1"	1"
R-32 Refrigerant Charge (oz.) (1)	178	178	178
R-32 Refrigerant Charge (oz.) (2)	163	163	163
Evaporator Coil Face Area (ft ²)	21.69	21.69	21.69
Rows Deep/ Fins per Inch	4/18	4/18	4/18
CONDENSER FAN / MCHX (MICROCHANNEL HEAT EXCHANGER)			
Quantity of Condenser Fan Motors	5	5	5
RPM (High/Low stage)	1130	1115	1075
Outdoor Horsepower	1/2	1/2	1/2
Fan Diameter/ # Fan Blades	22 / 3	22 / 3	22 / 3
Face Area (ft ²)	25.7	25.7	25.7
Rows Deep / Fins per Inch	1/23	1/23	1/23
COMPRESSOR			
Quantity / Type / Stages per Compression	2 / Scroll / 1	2 / Scroll / 1	2 / Scroll / 1
Compressor RLA / LRA	35.3 / 270	20.5 / 147	13.8 / 109.0
ELECTRICAL DATA			
Voltage-Phase-Frequency	208/230-3-60	460-3-60	575-3-60
Indoor Blower FLA	14.5	10.6	7.2
Max External Static (In. W.C.)	1.2	1.2	1.2
Outdoor Fan FLA	2.7	1.4	1
Min. Circuit Ampacity ¹	122/122	74.3	50.4
Max. Overcurrent Protection (A) ²	150/150	90	60
Power Supply Conduit Hole Dia. (in)	2.5	2.5	2.5
Low-Voltage Conduit Hole Dia. (in)	0.5	0.5	0.5
OPERATING WEIGHT (LBS.)			
	2129	2129	2129
SHIPPING WEIGHT (LBS.)			
	2244	2244	2244

¹ Wire size should be determined in accordance with National Electrical Codes. Extensive wire runs will require larger wire sizes.

² May use fuses or HACR-type circuit breakers of the same size as noted.

Note: Always check the S&R plate for electrical data on the unit being installed.

Coil Dimensions

MODEL	SIZE	FIN HEIGHT IN.	FIN LENGTH IN.
DSC	15	40	78.092
DSC	20	40	78.092
DSC	25	40	78.092

AHRI Ratings

MODEL	CAPACITY	EER	IEER
DSC1803D000001S	172,000	11.0	14.2
DSC1804D000001S	172,000	11.0	14.2
DSC1807D000001S	172,000	11.0	14.2
DSC2403D000001S	230,000	11.0	14.2
DSC2404D000001S	230,000	11.0	14.2
DSC2407D000001S	230,000	11.0	14.2
DSC3003D000001S	290,000	10.00	13.2
DSC3004D000001S	290,000	10.00	13.2
DSC3007D000001S	290,000	10.00	13.2

Sound Data

STATIC PRESSURE	Component	A-Weighted								
			63	125	250	500	1000	2000	4000	8000
STD	Discharge	79.1	90.5	82.3	79.7	78.7	73.0	67.6	64.4	53.7
	Inlet	78.5	93.0	87.3	80.9	75.1	72.2	67.6	64.4	53.7
HIGH	Discharge	84.6	91.4	87.3	86.1	84.1	78.7	73.4	69.8	60.0
	Inlet	76.9	91.6	86.6	84.1	70.9	66.5	60.3	58.7	49.7
	Outdoor	80.4	99.9	86.2	78.7	75.3	74.5	72.3	69.3	63.1

STATIC PRESSURE	Component	A-Weighted								
			63	125	250	500	1000	2000	4000	8000
STD	Discharge	79.6	87.9	81.7	81.0	79.0	74.0	67.4	65.0	55.7
	Inlet	70.3	89.7	81.7	74.8	62.4	58.7	54.5	53.6	47.2
HIGH	Discharge	84.6	83.5	84.9	84.4	83.8	79.9	73.4	70.1	62.6
	Inlet	72.3	82.1	79.3	75.0	71.2	64.5	61.6	59.1	51.9
	Outdoor	92.1	109.4	96.5	96.5	87.7	84.3	81.2	75.0	68.7

STATIC PRESSURE	Component	A-Weighted								
			63	125	250	500	1000	2000	4000	8000
STD	Discharge	86.4	85.7	87.4	88.4	85.6	81.2	74.5	70.5	61.1
	Inlet	74.4	88.1	82.8	81.4	68.1	66.2	59.1	56.1	46.5
HIGH	Discharge	86.5	89.7	88.3	88.0	85.3	81.7	75.4	71.0	61.7
	Inlet	76.0	89.8	87.4	80.0	69.7	68.3	61.7	58.0	48.6
	Outdoor	91.3	107.7	94.7	92.5	87.9	85.2	82.5	78.3	68.7

dB - decibel

¹ Indoor sound data is measured in accordance with AHRI 260. Outdoor sound is measured in accordance with AHRI 370

² Measurements are expressed in terms of sound power. Do not compare these values to sound pressure values because sound pressure depends on specific environment factors which normally do not match individual applications. Sound power values are independent of the environment and therefore more accurate.

³ A-weighted sound ratings filter out high and very low frequencies, to better approximate the response of "average" human ear. A-weighted measurements for Daikin units are taken in accordance with AHRI standard 260 for the indoor sound and AHRI 370 for the outdoor sound.

Dimensional Data

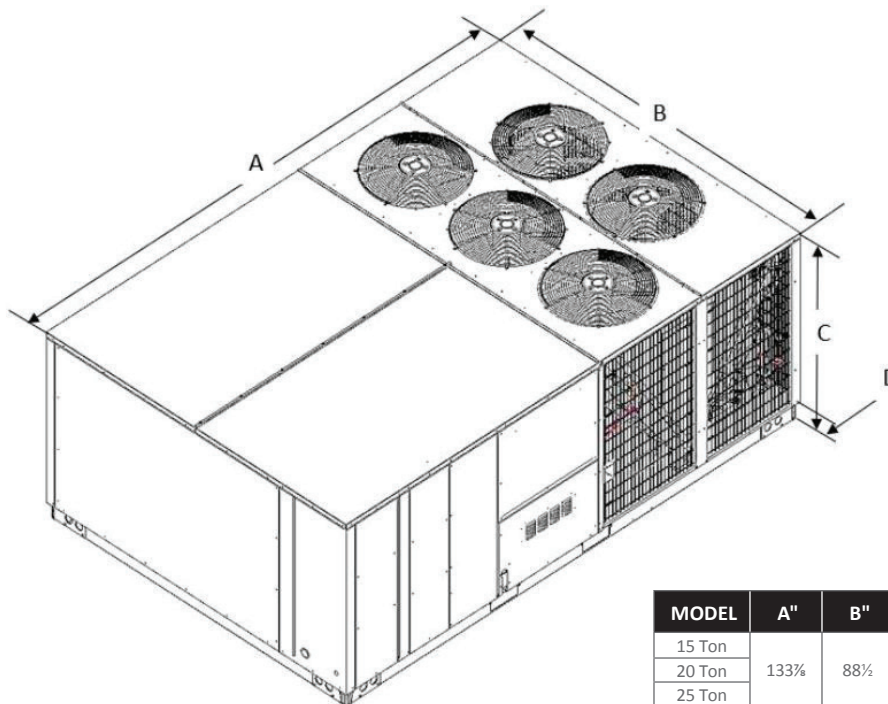

MODEL	A"	B"	C"	D"
15 Ton			$51\frac{1}{16}$	
20 Ton	133 $\frac{3}{8}$	88 $\frac{1}{2}$	51	5 $\frac{5}{32}$
25 Ton				

NOTE: 15 ton has 3 fans; 20 ton has 4 fans; 25 ton has 5 fans

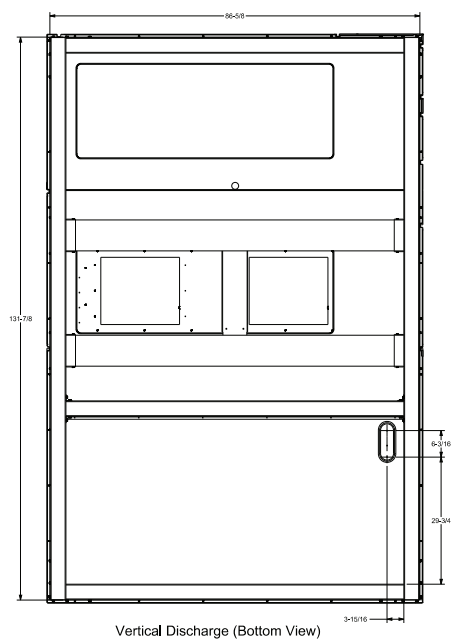

Vertical Discharge (Bottom View)

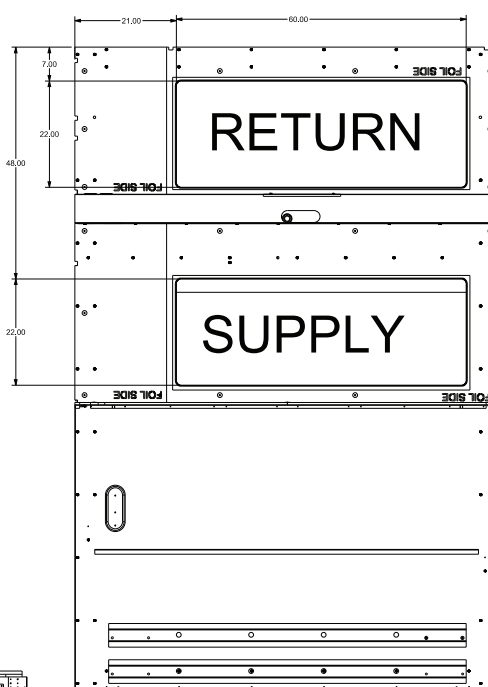

Vertical Discharge (Top View)

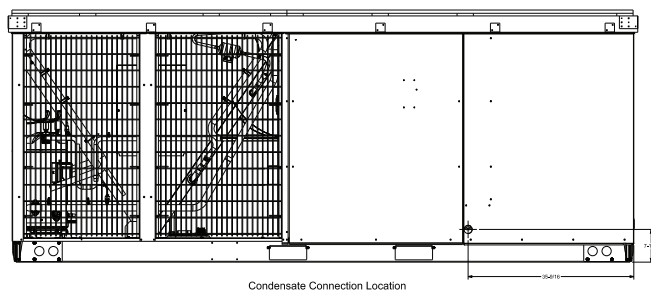

Condensate Connection Location

IDB		Outdoor Ambient Temperature												Entering Indoor Wet Bulb Temperature												Entering Indoor Dry Bulb Temperature																							
		65				75				85				95				105				115				65				75				85				95				105				115			
		59	63	67	71	59	63	67	71	59	63	67	71	59	63	67	71	59	63	67	71	59	63	67	71	59	63	67	71	59	63	67	71	59	63	67	71	59	63	67	71	59	63	67	71				
4500	MBh	174.6	177.0	182.3	-	173.0	175.5	180.7	-	168.4	170.9	176.1	-	160.6	163.1	168.3	-	151.0	153.4	158.7	-	142.2	144.7	149.9	-	142.2	144.7	149.9	-	142.2	144.7	149.9	-	142.2	144.7	149.9	-	142.2	144.7	149.9	-	142.2	144.7	149.9	-				
	S/T	0.60	0.53	0.42	-	0.60	0.54	0.42	-	0.63	0.56	0.44	-	0.65	0.58	0.45	-	0.68	0.61	0.47	-	0.77	0.68	0.54	-	0.77	0.68	0.54	-	0.77	0.68	0.54	-	0.77	0.68	0.54	-	0.77	0.68	0.54	-								
	ΔT	21.09	19.11	15.43	-	21.03	19.06	15.38	-	21.31	19.34	15.66	-	21.01	19.04	15.36	-	20.75	18.78	15.09	-	21.98	20.01	16.33	-	21.98	20.01	16.33	-	21.98	20.01	16.33	-	21.98	20.01	16.33	-	21.98	20.01	16.33	-								
	kW	10.91	10.90	10.88	-	12.32	12.31	12.29	-	13.90	13.89	13.86	-	15.60	15.59	15.57	-	17.50	17.49	17.47	-	19.74	19.73	19.70	-	19.74	19.73	19.70	-	19.74	19.73	19.70	-	19.74	19.73	19.70	-												
	Hi PR	263	264	266	-	304	305	307	-	348	349	351	-	394	396	397	-	445	446	448	-	499	500	502	-	499	500	502	-	499	500	502	-	499	500	502	-												
Lo PR	114	115	118	-	121	122	125	-	127	128	131	-	132	133	136	-	137	138	141	-	138	143	147	-	138	143	147	-	138	143	147	-	138	143	147	-													
70	MBh	176.5	179.0	184.2	-	174.9	177.4	182.6	-	170.3	172.8	178.0	-	162.5	165.0	170.2	-	152.9	155.4	160.6	-	144.1	146.6	151.8	-	144.1	146.6	151.8	-	144.1	146.6	151.8	-	144.1	146.6	151.8	-												
	S/T	0.63	0.56	0.43	-	0.63	0.56	0.44	-	0.66	0.59	0.46	-	0.68	0.60	0.47	-	0.71	0.63	0.49	-	0.80	0.72	0.56	-	0.80	0.72	0.56	-	0.80	0.72	0.56	-																
	ΔT	20.13	18.16	14.48	-	20.08	18.10	14.42	-	20.35	18.38	14.70	-	20.06	18.08	14.40	-	19.79	17.82	14.14	-	21.03	19.06	15.37	-	21.03	19.06	15.37	-	21.03	19.06	15.37	-																
	kW	10.97	10.96	10.94	-	12.38	12.37	12.35	-	13.96	13.95	13.92	-	15.66	15.65	15.62	-	17.56	17.55	17.53	-	19.79	19.78	19.76	-	19.79	19.78	19.76	-																				
	Hi PR	265	266	268	-	306	307	309	-	349	351	352	-	396	397	399	-	447	448	450	-	500	501	503	-	500	501	503	-																				
Lo PR	115	116	119	-	122	123	126	-	128	129	132	-	133	134	137	-	138	139	142	-	140	144	149	-	140	144	149	-																					
6000	MBh	181.1	183.6	188.8	-	179.5	182.0	187.2	-	174.9	177.4	182.6	-	167.1	169.6	174.8	-	157.5	160.0	165.2	-	148.7	151.2	156.4	-	148.7	151.2	156.4	-																				
	S/T	0.68	0.60	0.45	-	0.68	0.60	0.45	-	0.71	0.63	0.48	-	0.73	0.64	0.49	-	0.77	0.67	0.50	-	0.87	0.77	0.58	-																								
	ΔT	18.60	16.63	12.95	-	18.55	16.58	12.90	-	18.83	16.86	13.17	-	18.53	16.56	12.88	-	18.27	16.29	12.61	-	19.50	17.53	13.85	-																								
	kW	11.07	11.06	11.03	-	12.48	12.47	12.44	-	14.05	14.04	14.01	-	15.75	15.74	15.72	-	17.66	17.64	17.62	-	19.89	19.88	19.85	-																								
	Hi PR	268	269	271	-	310	311	313	-	353	354	356	-	400	401	403	-	450	451	453	-	504	505	507	-																								
Lo PR	118	119	122	-	125	126	129	-	131	132	135	-	136	137	140	-	141	142	145	-	143	149	152	-																									
4500	MBh	175.5	178.0	183.2	191.2	173.9	176.4	181.6	189.6	169.3	171.8	177.0	185.0	161.5	164.0	169.2	177.2	151.9	154.3	159.6	167.6	143.1	145.6	150.8	158.8																								
	S/T	0.72	0.65	0.53	0.41	0.72	0.66	0.54	0.42	0.75	0.68	0.56	0.43	0.78	0.71	0.58	0.44	0.82	0.74	0.60	0.46	0.91	0.83	0.68	0.53																								
	ΔT	25.42	23.45	19.77	16.0	25.37	23.40	19.71	15.9	25.64	23.67	19.99	16.2	25.35	23.37	19.69	15.9	25.08	23.11	19.43	15.6	26.32	24.35	20.66	16.8																								
	kW	10.91	10.89	10.87	11.0	12.32	12.30	12.28	12.4	13.89	13.88	13.85	14.0	15.59	15.58	15.56	15.7	17.49	17.48	17.46	17.6	19.73	19.72	19.69	19.8																								
	Hi PR	263	264	266	271	305	306	308	312	348	349	351	355	395	396	398	402	445	446	448	453	499	500	502	506																								
Lo PR	114	115	118	123	121	122	125	130	127	128	131	136	132	133	136	141	137	138	141	146	139	144	147	152																									
75	MBh	177.4	179.9	185.1	193.1	175.8	178.3	183.5	191.5	171.3	173.7	179.0	186.9	163.4	165.9	171.1	179.1	153.8	156.3	161.5	169.5	145.0	147.5	152.7	160.7																								
	S/T	0.76	0.69	0.56	0.43	0.77	0.69	0.56	0.43	0.79	0.72	0.59	0.45	0.82	0.75	0.60	0.46	0.87	0.78	0.63	0.48	0.96	0.87	0.71	0.55																								
	ΔT	24.47	22.49	18.81	15.0	24.41	22.44	18.76	14.9	24.69	22.72	19.04	15.2	24.39	22.42	18.74	14.9	24.13	22.16	18.47	14.7	25.36	23.39	19.71	15.9																								
	kW	10.96	10.95	10.93	11.0	12.37	12.36	12.34	12.4	13.95	13.94	13.91	14.0	15.65	15.64	15.62	15.7	17.55	17.54	17.52	17.6	19.79	19.77	19.75	19.9																								
	Hi PR	265	266	268	272	306	307	309	314	350	351	353	357	396	398	399	404	447	448	450	454	501	502	504	508																								
Lo PR	115	116	119	124	122	123	126	131	128	129	132	137	133	134	137	142	138	139	142	147	139	146	149	153																									
6000	MBh	182.0	184.5	189.7	197.7	180.4	182.9	188.1	196.1	175.9	178.3	183.6	191.5	168.0	170.5	175.7	183.7	158.4	160.9	166.1	174.1	149.6	152.1	157.3	165.3																								
	S/T	0.83	0.75	0.60	0.45	0.84	0.75	0.60	0.45	0.87	0.78	0.63	0.47	0.90	0.81	0.65	0.48	0.94	0.85	0.67	0.50	1.00	0.95	0.76	0.57																								
	ΔT	22.94	20.97	17.29	13.5	22.89	20.91	17.23	13.4	23.16	21.19	17.51	13.7	22.87	20.89	17.21	13.4	22.60	20.63	16.95	13.1	22.67	21.86	18.18	14.4																								
	kW	11.06	11.05	11.02	11.1	12.47	12.46	12.43	12.5	14.04	14.03	14.01	14.1	15.74	15.73	15.71	15.8	17.65	17.64	17.61	17.7	19.88	19.87	19.84	20.0																								
	Hi PR	268	269	271	276	310	311	313	317	353	354	356	361	400	401	403	407	450	451	453	458	504	505	507	512																								
Lo PR	118	119	122	127	125	126	129	134	131	132	135	140	136	137	140	145	138	142	145	150	147	149	152	156																									

High and low pressures are measured at the liquid and suction access fittings.

Shaded area reflects ACCA (TVA) conditions

IDB: Entering Indoor Dry Bulb Temperature

IDB		Outdoor Ambient Temperature																							
		65				75				85				95				105				115			
		Airflow	59	63	67	71	59	63	67	71	59	63	67	71	59	63	67	71	59	63	67	71	59	63	67
4500	MBh	176.4	178.9	184.1	192.1	174.8	177.3	182.5	190.5	170.3	172.7	178.0	185.9	162.4	164.9	170.1	178.1	152.8	155.3	160.5	168.5	144.0	146.5	151.7	159.7
	S/T	0.84	0.77	0.65	0.52	0.84	0.78	0.65	0.53	0.87	0.80	0.68	0.55	0.91	0.83	0.70	0.56	0.95	0.88	0.73	0.59	1.00	0.97	0.82	0.66
	ΔT	29.79	27.81	24.13	20.3	29.73	27.76	24.08	20.3	30.01	28.04	24.36	20.5	29.71	27.74	24.06	20.2	29.45	27.48	23.79	20.0	29.09	28.71	25.03	21.2
	kW	10.91	10.90	10.88	11.0	12.32	12.31	12.29	12.4	13.90	13.89	13.86	14.0	15.60	15.59	15.56	15.7	17.50	17.49	17.47	17.6	19.73	19.72	19.70	19.8
	Hi PR	264	265	267	271	305	306	308	313	348	350	351	356	395	396	398	403	445	447	448	453	499	500	502	507
	Lo PR	114	116	118	123	121	122	125	130	127	128	131	136	127	134	136	141	128	139	141	146	143	145	148	153
80	MBh	178.3	180.8	186.0	194.0	176.7	179.2	184.4	192.4	172.2	174.6	179.9	187.8	164.3	166.8	172.0	180.0	154.7	157.2	162.4	170.4	145.9	148.4	153.6	161.6
	S/T	0.89	0.82	0.69	0.55	0.90	0.82	0.69	0.55	0.93	0.85	0.72	0.57	0.96	0.89	0.74	0.59	1.00	0.93	0.78	0.62	1.00	1.00	0.86	0.69
	ΔT	28.83	26.86	23.18	19.4	28.78	26.81	23.12	19.3	29.05	27.08	23.40	19.6	28.76	26.79	23.10	19.3	28.06	26.52	22.84	19.0	26.47	26.92	24.07	20.3
	kW	10.97	10.96	10.94	11.0	12.38	12.37	12.35	12.5	13.95	13.94	13.92	14.0	15.66	15.65	15.62	15.7	17.56	17.55	17.53	17.6	19.79	19.78	19.76	19.9
	Hi PR	265	267	268	273	307	308	310	314	350	351	353	358	397	398	400	404	447	448	450	455	501	502	504	509
	Lo PR	116	117	120	125	122	124	127	132	127	130	133	138	127	135	138	143	139	140	143	148	145	152	149	154
6000	MBh	182.9	185.4	190.6	198.6	181.3	183.8	189.0	197.0	176.8	179.2	184.5	192.4	168.9	171.4	176.6	184.6	159.3	161.8	167.0	175.0	150.5	153.0	158.2	166.2
	S/T	0.99	0.90	0.75	0.59	0.99	0.91	0.75	0.60	1.00	0.94	0.78	0.62	1.00	0.97	0.81	0.64	1.00	1.00	0.84	0.66	1.00	1.00	0.94	0.74
	ΔT	27.30	25.33	21.65	17.8	27.25	25.28	21.60	17.8	26.78	25.56	21.87	18.1	25.59	25.26	21.58	17.8	24.14	24.51	21.31	17.5	22.81	23.18	22.55	18.7
	kW	11.06	11.05	11.03	11.1	12.47	12.46	12.44	12.5	14.05	14.04	14.01	14.1	15.75	15.74	15.72	15.8	17.65	17.64	17.62	17.7	19.89	19.88	19.85	20.0
	Hi PR	269	270	272	276	310	311	313	318	354	355	357	361	400	401	403	408	451	452	454	458	504	506	507	512
	Lo PR	119	120	123	128	125	127	130	135	131	133	136	141	137	138	141	146	142	143	146	151	148	153	152	157
4500	MBh	179.3	181.8	187.0	195.0	177.8	180.2	185.5	193.5	173.2	175.7	180.9	188.9	165.3	167.8	173.0	181.0	155.7	158.2	163.4	171.4	147.0	149.4	154.7	162.6
	S/T	0.93	0.86	0.74	0.61	0.94	0.87	0.75	0.62	0.97	0.90	0.77	0.64	1.00	0.93	0.80	0.66	1.00	0.98	0.84	0.69	1.00	1.00	0.92	0.76
	ΔT	33.66	31.69	28.00	24.2	33.60	31.63	27.95	24.1	33.88	31.91	28.23	24.4	33.40	31.61	27.93	24.1	31.46	31.35	27.67	23.9	29.69	30.19	28.90	25.1
	kW	10.94	10.93	10.90	11.0	12.35	12.34	12.31	12.4	13.92	13.91	13.89	14.0	15.63	15.62	15.59	15.7	17.53	17.52	17.49	17.6	19.76	19.75	19.73	19.8
	Hi PR	265	266	268	272	306	307	309	314	350	351	353	357	396	397	399	404	447	448	450	454	500	502	503	508
	Lo PR	115	117	120	125	115	124	127	132	114	130	133	138	134	135	138	143	139	140	143	148	145	147	149	154
85	MBh	181.2	183.7	188.9	196.9	179.7	182.2	187.4	195.4	175.1	177.6	182.8	190.8	167.2	169.7	174.9	182.9	157.6	160.1	165.3	173.3	148.9	151.3	156.6	164.6
	S/T	0.99	0.92	0.79	0.65	1.00	0.93	0.79	0.65	1.00	0.96	0.82	0.68	1.00	1.00	0.85	0.70	1.00	1.00	0.89	0.73	1.00	1.00	0.98	0.81
	ΔT	32.70	30.73	27.05	23.2	32.59	30.68	26.99	23.2	31.76	30.95	27.27	23.5	30.34	30.66	26.97	23.2	28.59	29.04	26.71	22.9	27.00	27.45	27.95	24.1
	kW	11.00	10.99	10.96	11.1	12.41	12.40	12.37	12.5	13.98	13.97	13.95	14.1	15.68	15.67	15.65	15.8	17.59	17.58	17.55	17.7	19.82	19.81	19.78	19.9
	Hi PR	267	268	270	274	308	309	311	316	351	353	354	359	398	399	401	406	449	450	452	456	502	503	505	510
	Lo PR	115	119	122	126	124	126	128	133	130	132	134	139	135	137	140	144	140	143	145	149	147	148	151	156
6000	MBh	185.8	188.3	193.5	201.5	184.3	186.8	192.0	200.0	179.7	182.2	187.4	195.4	171.8	174.3	179.5	187.5	162.2	164.7	169.9	177.9	153.5	155.9	161.2	169.2
	S/T	1.00	1.00	0.87	0.71	1.00	1.00	0.88	0.71	1.00	1.00	0.91	0.74	1.00	1.00	0.94	0.76	1.00	1.00	0.98	0.79	1.00	1.00	1.00	0.88
	ΔT	28.16	28.53	25.52	21.7	27.92	28.30	25.47	21.7	27.23	27.60	25.75	21.9	26.04	26.41	25.45	21.6	24.58	24.96	25.18	21.4	23.25	23.63	24.42	22.6
	kW	11.09	11.08	11.06	11.2	12.50	12.49	12.47	12.6	14.08	14.06	14.04	14.1	15.78	15.77	15.74	15.9	17.68	17.67	17.65	17.8	19.91	19.90	19.88	20.0
	Hi PR	270	271	273	278	311	313	314	319	355	356	358	362	402	403	405	409	452	453	455	460	506	507	509	513
	Lo PR	120	142	125	129	127	143	131	136	133	142	137	142	138	144	143	147	143	145	148	152	150	151	167	159

High and low pressures are measured at the liquid and suction access fittings.

Shaded area reflects ACCA (TVA) conditions

IDB: Entering Indoor Dry Bulb Temperature

IDB		Outdoor Ambient Temperature																							
		65				75				85				95				105				115			
		59	63	67	71	59	63	67	71	59	63	67	71	59	63	67	71	59	63	67	71	59	63	67	71
		Entering Indoor Wet Bulb Temperature																							
		Entering Indoor Dry Bulb Temperature																							
		Airflow																							
6000	MBh	234.4	237.7	244.7	-	232.3	235.6	242.6	-	226.2	229.5	236.5	-	215.7	219.0	226.0	-	202.8	206.1	213.1	-	191.1	194.4	201.4	-
	S/T	0.58	0.52	0.41	-	0.59	0.52	0.41	-	0.61	0.54	0.43	-	0.63	0.56	0.44	-	0.66	0.59	0.46	-	0.75	0.67	0.52	-
	ΔT	20.70	18.72	15.04	-	20.64	18.67	14.99	-	20.92	18.95	15.27	-	20.62	18.65	14.97	-	20.36	18.39	14.71	-	21.59	19.62	15.94	-
	KW	15.40	15.39	15.36	-	17.17	17.16	17.13	-	19.15	19.13	19.10	-	21.28	21.27	21.24	-	23.67	23.66	23.63	-	26.47	26.46	26.42	-
	Hi PR	266	267	269	-	308	309	311	-	352	353	355	-	399	400	402	-	450	451	453	-	504	505	507	-
	Lo PR	121	122	125	-	128	129	133	-	134	136	139	-	140	141	144	-	141	147	150	-	139	144	154	-
70	MBh	236.0	239.3	246.3	-	233.9	237.2	244.2	-	227.8	231.1	238.1	-	217.3	220.6	227.6	-	204.4	207.7	214.7	-	192.7	196.0	203.0	-
	S/T	0.60	0.53	0.41	-	0.60	0.54	0.42	-	0.63	0.56	0.43	-	0.65	0.58	0.45	-	0.68	0.60	0.46	-	0.77	0.68	0.53	-
	ΔT	20.13	18.16	14.48	-	20.08	18.10	14.42	-	20.35	18.38	14.70	-	20.06	18.08	14.40	-	19.79	17.82	14.14	-	21.03	19.06	15.37	-
	KW	15.45	15.43	15.40	-	17.22	17.20	17.17	-	19.19	19.18	19.15	-	21.33	21.31	21.28	-	23.71	23.70	23.67	-	26.51	26.50	26.47	-
	Hi PR	267	268	270	-	309	310	312	-	353	354	356	-	400	401	403	-	451	452	454	-	505	506	508	-
	Lo PR	122	123	126	-	129	130	133	-	135	137	140	-	141	142	145	-	143	147	151	-	140	145	155	-
8000	MBh	244.1	247.4	254.4	-	242.0	245.3	252.3	-	235.9	239.2	246.2	-	225.4	228.7	235.7	-	212.6	215.9	222.9	-	200.8	204.1	211.1	-
	S/T	0.66	0.58	0.44	-	0.66	0.58	0.44	-	0.69	0.61	0.46	-	0.71	0.62	0.47	-	0.74	0.65	0.48	-	0.84	0.74	0.56	-
	ΔT	18.24	16.27	12.58	-	18.18	16.21	12.53	-	18.46	16.49	12.81	-	18.16	16.19	12.51	-	17.90	15.93	12.25	-	19.14	17.16	13.48	-
	KW	15.59	15.58	15.55	-	17.36	17.35	17.32	-	19.33	19.32	19.29	-	21.47	21.46	21.43	-	23.86	23.84	23.81	-	26.66	26.64	26.61	-
	Hi PR	272	273	275	-	313	315	316	-	357	358	360	-	404	406	407	-	455	456	458	-	510	511	513	-
	Lo PR	126	127	130	-	133	135	138	-	139	141	144	-	145	146	149	-	148	152	155	-	145	150	160	-
6000	MBh	235.6	238.9	245.9	256.6	233.5	236.8	243.8	254.5	227.4	230.7	237.7	248.4	216.9	220.2	227.2	237.9	204.0	207.3	214.3	225.0	192.3	195.6	202.6	213.3
	S/T	0.70	0.64	0.52	0.40	0.71	0.64	0.52	0.40	0.73	0.67	0.54	0.42	0.76	0.69	0.56	0.43	0.80	0.72	0.59	0.45	0.89	0.81	0.66	0.51
	ΔT	25.03	23.06	19.38	15.6	24.98	23.01	19.32	15.5	25.26	23.28	19.60	15.8	24.96	22.99	19.30	15.5	24.69	22.72	19.04	15.2	25.93	23.96	20.28	16.5
	KW	15.39	15.38	15.35	15.5	17.16	17.15	17.12	17.3	19.14	19.12	19.09	19.2	21.27	21.26	21.23	21.4	23.66	23.64	23.61	23.7	26.46	26.44	26.41	26.5
	Hi PR	266	267	269	274	308	309	311	316	352	353	355	360	399	400	402	407	450	451	453	458	504	505	507	512
	Lo PR	121	122	125	130	128	129	133	138	134	136	139	144	139	141	144	149	139	147	150	155	139	145	155	161
75	MBh	237.2	240.5	247.5	258.2	235.1	238.4	245.4	256.1	229.0	232.3	239.3	250.0	218.5	221.8	228.8	239.5	205.6	208.9	215.9	226.6	193.9	197.2	204.2	214.9
	S/T	0.73	0.66	0.54	0.41	0.73	0.66	0.54	0.41	0.76	0.69	0.56	0.43	0.79	0.71	0.58	0.44	0.83	0.75	0.60	0.46	0.92	0.83	0.68	0.52
	ΔT	24.47	22.49	18.81	15.0	24.41	22.44	18.76	14.9	24.69	22.72	19.04	15.2	24.39	22.42	18.74	14.9	24.13	22.16	18.47	14.7	25.36	23.39	19.71	15.9
	KW	15.44	15.42	15.39	15.5	17.20	17.19	17.16	17.3	19.18	19.16	19.13	19.3	21.31	21.30	21.27	21.4	23.70	23.69	23.66	23.8	26.50	26.49	26.46	26.6
	Hi PR	267	269	270	275	309	310	312	317	353	354	356	361	400	401	403	408	451	452	454	459	505	507	508	513
	Lo PR	122	123	126	131	129	130	133	138	135	137	140	145	139	142	145	150	140	147	151	156	140	146	157	162
8000	MBh	245.3	248.6	255.6	266.3	243.2	246.5	253.5	264.2	237.1	240.4	247.4	258.1	226.6	229.9	236.9	247.6	213.8	217.1	224.1	234.7	202.0	205.3	212.3	223.0
	S/T	0.81	0.73	0.58	0.43	0.81	0.73	0.59	0.43	0.85	0.76	0.61	0.45	0.87	0.79	0.63	0.46	0.92	0.82	0.65	0.48	1.00	0.92	0.74	0.55
	ΔT	22.57	20.60	16.92	13.1	22.52	20.55	16.87	13.1	22.80	20.83	17.14	13.3	22.50	20.53	16.85	13.0	22.24	20.26	16.58	12.8	22.96	21.50	17.82	14.0
	KW	15.58	15.57	15.54	15.7	17.35	17.34	17.31	17.4	19.32	19.31	19.28	19.4	21.46	21.45	21.42	21.6	23.85	23.83	23.80	23.9	26.65	26.63	26.60	26.7
	Hi PR	272	273	275	280	314	315	317	321	357	359	361	365	405	406	408	412	456	457	459	463	510	511	513	517
	Lo PR	126	127	130	135	133	135	138	143	139	141	144	149	140	146	149	155	138	152	155	160	148	152	161	166

High and low pressures are measured at the liquid and suction access fittings.

Shaded area reflects ACCA (TVA) conditions

IDB: Entering Indoor Dry Bulb Temperature

IDB	Airflow	Outdoor Ambient Temperature																							
		65				75				85				95				105				115			
		59	63	67	71	59	63	67	71	59	63	67	71	59	63	67	71	59	63	67	71	59	63	67	71
6000	MBh	236.8	240.1	247.1	257.8	234.7	238.0	245.0	255.7	228.6	231.9	238.9	249.6	218.1	221.4	228.4	239.1	205.2	208.6	215.5	226.2	193.5	196.8	203.8	214.5
	S/T	0.82	0.75	0.63	0.51	0.83	0.76	0.64	0.51	0.86	0.79	0.66	0.53	0.89	0.82	0.68	0.55	0.93	0.86	0.72	0.57	1.00	0.95	0.80	0.64
	ΔT	29.40	27.43	23.74	19.9	29.34	27.37	23.69	19.9	29.62	27.65	23.97	20.2	29.32	27.35	23.67	19.9	29.06	27.09	23.41	19.6	29.32	28.32	24.64	20.8
	kW	15.40	15.39	15.36	15.5	17.17	17.16	17.13	17.3	19.14	19.13	19.10	19.2	21.28	21.27	21.24	21.4	23.67	23.65	23.62	23.8	26.47	26.45	26.42	26.6
	Hi PR	267	268	270	274	309	310	312	316	352	354	355	360	400	401	403	407	450	452	453	458	505	506	508	512
	Lo PR	121	123	126	131	127	130	133	138	127	136	139	145	127	142	145	150	127	147	150	155	144	147	157	162
80	MBh	238.4	241.7	248.7	259.4	236.3	239.6	246.6	257.3	230.2	233.5	240.5	251.2	219.7	223.0	230.0	240.7	206.9	210.2	217.2	227.8	195.1	198.4	205.4	216.1
	S/T	0.85	0.78	0.66	0.53	0.86	0.79	0.66	0.53	0.89	0.82	0.68	0.55	0.92	0.85	0.71	0.56	0.97	0.89	0.74	0.59	1.00	0.98	0.83	0.66
	ΔT	28.83	26.86	23.18	19.4	28.78	26.81	23.12	19.3	29.05	27.08	23.40	19.6	28.76	26.79	23.10	19.3	28.49	26.52	22.84	19.0	27.72	27.76	24.07	20.3
	kW	15.45	15.43	15.40	15.5	17.21	17.20	17.17	17.3	19.19	19.17	19.14	19.3	21.32	21.31	21.28	21.4	23.71	23.70	23.67	23.8	26.51	26.50	26.47	26.6
	Hi PR	268	269	271	276	310	311	313	317	354	355	357	361	401	402	404	408	452	453	455	459	506	507	509	513
	Lo PR	122	124	127	132	128	131	134	139	128	137	140	145	127	143	146	151	127	148	151	156	149	148	158	163
8000	MBh	246.5	249.9	256.8	267.5	244.5	247.8	254.7	265.4	238.3	241.6	248.6	259.3	227.8	231.1	238.1	248.8	215.0	218.3	225.3	236.0	203.3	206.6	213.5	224.2
	S/T	0.96	0.88	0.73	0.57	0.97	0.88	0.73	0.58	1.00	0.92	0.76	0.60	1.00	0.95	0.78	0.62	1.00	0.99	0.82	0.64	1.00	1.00	0.91	0.72
	ΔT	26.94	24.97	21.29	17.5	26.89	24.91	21.23	17.4	27.08	25.19	21.51	17.7	25.89	24.89	21.21	17.4	24.43	24.63	20.95	17.1	23.10	23.47	22.18	18.4
	kW	15.59	15.58	15.55	15.7	17.36	17.35	17.31	17.5	19.33	19.32	19.29	19.4	21.47	21.45	21.42	21.6	23.86	23.84	23.81	23.9	26.66	26.64	26.61	26.7
	Hi PR	272	274	275	280	314	315	317	322	358	359	361	366	405	406	408	413	456	457	459	464	510	511	513	518
	Lo PR	126	128	131	136	127	135	138	143	140	141	145	150	145	147	150	155	151	152	155	160	157	159	162	167
6000	MBh	240.8	244.1	251.1	261.7	238.7	242.0	249.0	259.6	232.6	235.9	242.8	253.5	222.0	225.3	232.3	243.0	209.2	212.5	219.5	230.2	197.5	200.8	207.8	218.4
	S/T	0.91	0.85	0.73	0.60	0.92	0.85	0.73	0.60	0.95	0.88	0.76	0.63	0.99	0.91	0.78	0.64	1.00	0.96	0.82	0.67	1.00	1.00	0.91	0.75
	ΔT	33.27	31.30	27.61	23.8	33.21	31.24	27.56	23.7	33.49	31.52	27.84	24.0	33.19	31.22	27.54	23.7	31.70	30.96	27.28	23.5	29.92	30.42	28.51	24.7
	kW	15.44	15.42	15.39	15.5	17.20	17.19	17.16	17.3	19.18	19.16	19.13	19.3	21.31	21.30	21.27	21.4	23.70	23.69	23.66	23.8	26.50	26.49	26.46	26.6
	Hi PR	268	269	271	276	310	311	313	318	354	355	357	361	401	402	404	408	452	453	455	459	506	507	509	514
	Lo PR	115	125	128	133	115	132	135	140	115	138	141	146	115	142	147	152	147	141	152	157	154	156	159	164
6400	MBh	242.4	245.7	252.7	263.3	240.3	243.6	250.6	261.2	234.2	237.5	244.5	255.1	223.6	227.0	233.9	244.6	210.8	214.1	221.1	231.8	199.1	202.4	209.4	220.0
	S/T	0.95	0.88	0.75	0.62	0.96	0.89	0.76	0.62	0.99	0.92	0.79	0.65	1.00	0.95	0.81	0.67	1.00	1.00	0.85	0.70	1.00	1.00	0.94	0.77
	ΔT	32.70	30.73	27.05	23.2	32.65	30.68	26.99	23.2	32.93	30.95	27.27	23.5	31.77	30.66	26.97	23.2	29.94	30.39	26.71	22.9	28.28	28.75	27.95	24.1
	kW	15.48	15.47	15.44	15.6	17.25	17.23	17.20	17.3	19.22	19.21	19.18	19.3	21.36	21.34	21.31	21.4	23.74	23.73	23.70	23.8	26.54	26.53	26.50	26.6
	Hi PR	269	270	272	277	311	312	314	319	355	356	358	362	402	403	405	410	453	454	456	460	507	508	510	515
	Lo PR	115	125	128	134	114	133	136	141	114	139	142	147	143	142	148	153	148	142	153	158	155	156	159	165
8000	MBh	250.5	253.8	260.8	271.5	248.4	251.7	258.7	269.4	242.3	245.6	252.6	263.3	231.8	235.1	242.1	252.7	218.9	222.2	229.2	239.9	207.2	210.5	217.5	228.2
	S/T	1.00	1.00	0.85	0.69	1.00	1.00	0.85	0.70	1.00	1.00	0.88	0.72	1.00	1.00	0.91	0.74	1.00	1.00	0.95	0.77	1.00	1.00	1.00	0.86
	ΔT	28.46	28.84	25.16	21.3	28.23	28.60	25.10	21.3	27.53	27.91	25.38	21.6	26.34	26.71	25.08	21.3	24.88	25.25	24.82	21.0	23.54	23.92	24.71	22.2
	kW	15.62	15.61	15.58	15.7	17.39	17.38	17.35	17.5	19.37	19.35	19.32	19.5	21.50	21.49	21.46	21.6	23.89	23.88	23.84	24.0	26.69	26.68	26.64	26.8
	Hi PR	274	275	277	281	315	317	318	323	359	360	362	367	406	408	409	414	457	458	460	465	512	513	515	519
	Lo PR	128	130	133	138	135	143	140	145	142	143	146	151	147	149	152	157	153	154	157	162	159	161	166	169

IDB: Entering Indoor Dry Bulb Temperature Shaded area reflects ACCA (TVA) conditions High and low pressures are measured at the liquid and suction access fittings.

IDB		Outdoor Ambient Temperature																							
		65				75				85				95				105				115			
		59	63	67	71	59	63	67	71	59	63	67	71	59	63	67	71	59	63	67	71	59	63	67	71
		Entering Indoor Wet Bulb Temperature																							
		Entering Indoor Dry Bulb Temperature																							
70	MBh	296.9	301.1	309.9	-	294.3	298.4	307.2	-	286.6	290.7	299.5	-	273.3	277.5	286.3	-	257.1	261.3	270.1	-	242.3	246.5	255.3	-
	S/T	0.56	0.50	0.39	-	0.56	0.50	0.39	-	0.59	0.52	0.41	-	0.61	0.54	0.42	-	0.64	0.56	0.43	-	0.72	0.64	0.50	-
	ΔT	20.17	18.21	14.55	-	20.12	18.16	14.50	-	20.39	18.43	14.78	-	20.10	18.14	14.48	-	19.83	17.88	14.22	-	21.06	19.10	15.44	-
	kW	21.02	21.01	20.96	-	23.43	23.41	23.37	-	26.12	26.10	26.06	-	29.03	29.01	28.97	-	32.28	32.26	32.22	-	36.10	36.08	36.04	-
	Hi PR	280	281	283	-	323	325	326	-	369	370	372	-	419	420	422	-	472	473	475	-	529	530	532	-
Lo PR	122	123	126	-	129	130	134	-	135	137	140	-	141	142	145	-	143	148	151	-	140	145	155	-	
70	MBh	297.6	301.7	310.5	-	294.9	299.1	307.9	-	287.2	291.4	300.2	-	274.0	278.1	286.9	-	257.8	261.9	270.7	-	243.0	247.1	256.0	-
	S/T	0.57	0.50	0.39	-	0.57	0.51	0.39	-	0.59	0.53	0.41	-	0.61	0.54	0.42	-	0.64	0.57	0.44	-	0.72	0.64	0.50	-
	ΔT	20.00	18.04	14.38	-	19.95	17.99	14.33	-	20.22	18.26	14.60	-	19.93	17.97	14.31	-	19.66	17.70	14.05	-	20.89	18.93	15.27	-
	kW	21.04	21.02	20.98	-	23.45	23.43	23.39	-	26.14	26.12	26.08	-	29.05	29.03	28.99	-	32.30	32.28	32.24	-	36.12	36.10	36.06	-
	Hi PR	280	281	283	-	324	325	327	-	370	371	373	-	419	420	422	-	472	473	475	-	529	530	532	-
Lo PR	122	123	126	-	129	131	134	-	136	137	140	-	141	143	146	-	144	148	151	-	140	145	155	-	
10000	MBh	310.7	314.9	323.7	-	308.1	312.2	321.1	-	300.4	304.5	313.4	-	287.1	291.3	300.1	-	270.9	275.1	283.9	-	256.1	260.3	269.1	-
	S/T	0.63	0.55	0.41	-	0.63	0.55	0.41	-	0.66	0.58	0.43	-	0.68	0.59	0.44	-	0.71	0.62	0.46	-	0.80	0.70	0.53	-
	ΔT	17.74	15.78	12.12	-	17.69	15.73	12.07	-	17.96	16.00	12.34	-	17.67	15.71	12.05	-	17.40	15.44	11.79	-	18.63	16.67	13.01	-
	kW	21.28	21.26	21.22	-	23.69	23.67	23.63	-	26.38	26.36	26.32	-	29.29	29.27	29.23	-	32.54	32.52	32.48	-	36.35	36.33	36.29	-
	Hi PR	286	287	289	-	329	331	333	-	375	377	378	-	425	426	428	-	478	479	481	-	535	536	538	-
Lo PR	127	129	132	-	135	136	139	-	141	142	146	-	146	148	151	-	149	153	156	-	147	152	162	-	
7500	MBh	298.4	302.6	311.4	324.9	295.8	300.0	308.8	322.2	288.1	292.3	301.1	314.5	274.8	279.0	287.8	301.3	258.6	262.8	271.6	285.1	243.8	248.0	256.8	270.3
	S/T	0.68	0.61	0.50	0.38	0.68	0.62	0.50	0.38	0.71	0.64	0.52	0.40	0.73	0.66	0.54	0.41	0.77	0.70	0.56	0.43	0.86	0.78	0.63	0.49
	ΔT	24.48	22.52	18.86	15.1	24.42	22.46	18.81	15.0	24.70	22.74	19.08	15.3	24.40	22.44	18.79	15.0	24.14	22.18	18.53	14.7	25.37	23.41	19.75	16.0
	kW	21.01	20.99	20.95	21.1	23.42	23.40	23.36	23.5	26.11	26.09	26.05	26.2	29.02	29.00	28.96	29.1	32.27	32.25	32.21	32.4	36.08	36.06	36.02	36.2
	Hi PR	280	281	283	288	324	325	327	332	369	371	373	377	419	420	422	427	472	473	475	480	529	530	532	537
Lo PR	122	123	126	131	129	130	134	139	135	137	140	145	140	142	145	150	140	148	151	156	138	146	157	162	
7500	MBh	299.1	303.3	312.1	325.5	296.4	300.6	309.4	322.9	288.7	292.9	301.7	315.2	275.5	279.7	288.5	301.9	259.3	263.5	272.3	285.7	244.5	248.7	257.5	270.9
	S/T	0.68	0.62	0.50	0.39	0.69	0.62	0.51	0.39	0.71	0.65	0.53	0.40	0.74	0.67	0.54	0.41	0.78	0.70	0.57	0.43	0.87	0.79	0.64	0.49
	ΔT	24.31	22.35	18.69	14.9	24.25	22.29	18.64	14.8	24.53	22.57	18.91	15.1	24.23	22.27	18.62	14.8	23.97	22.01	18.35	14.6	25.20	23.24	19.58	15.8
	kW	21.03	21.01	20.97	21.2	23.44	23.42	23.38	23.6	26.12	26.11	26.06	26.2	29.03	29.02	28.97	29.2	32.29	32.27	32.23	32.4	36.10	36.08	36.04	36.2
	Hi PR	280	281	283	288	324	325	327	332	370	371	373	378	419	420	422	427	472	474	476	480	529	531	532	537
Lo PR	122	123	127	132	129	131	134	139	136	137	140	145	138	143	146	151	139	148	151	156	139	147	158	163	
7500	MBh	312.2	316.4	325.2	338.7	309.6	313.8	322.6	336.0	301.9	306.1	314.9	328.3	288.6	292.8	301.6	315.1	272.4	276.6	285.4	298.9	257.7	261.8	270.6	284.1
	S/T	0.78	0.70	0.56	0.41	0.78	0.70	0.56	0.41	0.81	0.73	0.58	0.43	0.84	0.75	0.60	0.44	0.88	0.79	0.62	0.45	0.98	0.88	0.70	0.52
	ΔT	22.05	20.09	16.43	12.6	21.99	20.03	16.38	12.6	22.27	20.31	16.65	12.9	21.97	20.01	16.36	12.6	21.71	19.75	16.09	12.3	22.94	20.98	17.32	13.5
	kW	21.26	21.24	21.20	21.4	23.67	23.65	23.61	23.8	26.36	26.34	26.30	26.5	29.27	29.25	29.21	29.4	32.52	32.50	32.46	32.6	36.34	36.32	36.28	36.5
	Hi PR	286	287	289	294	330	331	333	338	376	377	379	384	425	426	428	433	478	479	481	486	535	536	538	543
Lo PR	127	129	132	137	135	136	139	144	140	142	146	151	139	148	151	156	139	153	156	161	139	153	163	168	

High and low pressures are measured at the liquid and suction access fittings.

Shaded area reflects ACCA (TVA) conditions

IDB: Entering Indoor Dry Bulb Temperature

IDB		Outdoor Ambient Temperature																							
		65				75				85				95				105				115			
		Airflow	59	63	67	71	59	63	67	71	59	63	67	71	59	63	67	71	59	63	67	71	59	63	67
7500	MBh	300.0	304.1	312.9	326.4	297.3	301.5	310.3	323.8	289.6	293.8	302.6	316.1	276.4	280.5	289.3	302.8	260.2	264.3	273.1	286.6	245.4	249.5	258.4	271.8
	S/T	0.79	0.73	0.61	0.49	0.80	0.73	0.62	0.49	0.83	0.76	0.64	0.51	0.86	0.79	0.66	0.53	0.90	0.83	0.69	0.55	1.00	0.92	0.77	0.62
	ΔT	28.81	26.85	23.20	19.4	28.76	26.80	23.14	19.4	29.04	27.08	23.42	19.6	28.74	26.78	23.12	19.3	28.48	26.52	22.86	19.1	29.71	27.75	24.09	20.3
	kW	21.02	21.00	20.96	21.1	23.43	23.41	23.37	23.6	26.12	26.10	26.06	26.2	29.03	29.01	28.97	29.2	32.28	32.26	32.22	32.4	36.10	36.08	36.04	36.2
	Hi PR	280	281	283	288	324	325	327	332	370	371	373	378	419	421	422	427	473	474	476	481	529	531	533	537
	Lo PR	122	124	127	132	128	131	134	139	128	137	140	146	127	143	146	151	127	148	151	156	127	148	158	163
80	MBh	300.6	304.8	313.6	327.1	298.0	302.1	311.0	324.4	290.3	294.4	303.3	316.7	277.0	281.2	290.0	303.5	260.8	265.0	273.8	287.3	246.0	250.2	259.0	272.5
	S/T	0.80	0.74	0.62	0.49	0.81	0.74	0.62	0.50	0.84	0.77	0.65	0.52	0.87	0.80	0.67	0.53	0.91	0.84	0.70	0.55	1.00	0.93	0.78	0.62
	ΔT	28.64	26.68	23.03	19.2	28.59	26.63	22.97	19.2	28.86	26.91	23.25	19.5	28.57	26.61	22.95	19.2	28.31	26.35	22.69	18.9	29.24	27.58	23.92	20.1
	kW	21.04	21.02	20.98	21.2	23.45	23.43	23.39	23.6	26.14	26.12	26.08	26.3	29.05	29.03	28.99	29.2	32.30	32.28	32.24	32.4	36.11	36.09	36.05	36.2
	Hi PR	281	282	284	289	324	326	328	332	370	372	373	378	420	421	423	428	473	474	476	481	530	531	533	538
	Lo PR	122	124	127	132	127	131	134	139	127	138	141	146	127	143	146	151	127	148	151	157	145	149	158	163
10000	MBh	313.8	317.9	326.8	340.2	311.1	315.3	324.1	337.6	303.4	307.6	316.4	329.9	290.2	294.3	303.2	316.6	274.0	278.1	287.0	300.4	259.2	263.4	272.2	285.6
	S/T	0.92	0.84	0.70	0.55	0.93	0.85	0.70	0.55	0.96	0.88	0.73	0.57	1.00	0.91	0.75	0.59	1.00	0.95	0.78	0.61	1.00	1.00	0.88	0.69
	ΔT	26.38	24.42	20.77	17.0	26.33	24.37	20.71	16.9	26.60	24.65	20.99	17.2	26.31	24.35	20.69	16.9	24.91	24.09	20.43	16.6	23.56	23.94	21.66	17.9
	kW	21.28	21.26	21.22	21.4	23.69	23.67	23.62	23.8	26.37	26.36	26.31	26.5	29.28	29.27	29.22	29.4	32.54	32.52	32.48	32.7	36.35	36.33	36.29	36.5
	Hi PR	286	288	290	294	330	331	333	338	376	377	379	384	425	427	429	433	479	480	482	487	536	537	539	544
	Lo PR	128	129	132	137	127	137	140	145	127	143	146	151	127	148	151	157	152	152	152	157	152	152	159	163
7500	MBh	304.9	309.1	317.9	331.4	302.3	306.5	315.3	328.7	294.6	298.8	307.6	321.0	281.3	285.5	294.3	307.8	265.1	269.3	278.1	291.6	250.3	254.5	263.3	276.8
	S/T	0.88	0.82	0.70	0.58	0.89	0.83	0.71	0.58	0.92	0.85	0.73	0.60	0.96	0.89	0.76	0.62	1.00	0.93	0.79	0.65	1.00	1.00	0.88	0.72
	ΔT	32.66	30.70	27.04	23.3	32.61	30.65	26.99	23.2	32.88	30.92	27.27	23.5	32.59	30.63	26.97	23.2	32.14	30.37	26.71	22.9	30.34	30.85	27.93	24.1
	kW	21.07	21.05	21.01	21.2	23.48	23.46	23.42	23.6	26.17	26.15	26.11	26.3	29.08	29.06	29.02	29.2	32.33	32.31	32.27	32.5	36.14	36.12	36.08	36.3
	Hi PR	282	283	285	290	325	327	329	333	371	372	374	379	421	422	424	429	474	475	477	482	531	532	534	539
	Lo PR	115	125	129	134	114	133	136	141	114	139	142	147	115	142	148	153	148	142	142	153	155	154	160	165
85	MBh	305.6	309.8	318.6	332.0	302.9	307.1	315.9	329.4	295.2	299.4	308.2	321.7	282.0	286.2	295.0	308.4	265.8	270.0	278.8	292.2	251.0	255.2	264.0	277.4
	S/T	0.89	0.83	0.71	0.59	0.90	0.84	0.71	0.59	0.93	0.86	0.74	0.61	0.97	0.90	0.76	0.63	1.00	0.94	0.80	0.66	1.00	1.00	0.89	0.73
	ΔT	32.49	30.53	26.87	23.1	32.44	30.48	26.82	23.0	32.71	30.75	27.09	23.3	32.42	30.46	26.80	23.0	31.59	30.19	26.54	22.7	29.83	30.32	27.76	24.0
	kW	21.09	21.07	21.03	21.2	23.49	23.48	23.43	23.6	26.18	26.16	26.12	26.3	29.09	29.07	29.03	29.2	32.34	32.33	32.28	32.5	36.16	36.14	36.10	36.3
	Hi PR	282	283	285	290	326	327	329	334	372	373	375	380	421	422	424	429	474	475	477	482	531	532	534	539
	Lo PR	115	126	129	134	115	133	136	141	115	139	143	148	115	142	148	153	149	141	141	153	155	156	160	165
10000	MBh	318.7	322.9	331.7	345.2	316.1	320.3	329.1	342.5	308.4	312.6	321.4	334.8	295.1	299.3	308.1	321.6	278.9	283.1	291.9	305.4	264.2	268.3	277.1	290.6
	S/T	1.00	0.96	0.82	0.66	1.00	0.97	0.82	0.67	1.00	1.00	0.85	0.69	1.00	1.00	0.88	0.71	1.00	1.00	0.91	0.74	1.00	1.00	0.82	
	ΔT	28.98	28.27	24.61	20.8	28.74	28.22	24.56	20.8	28.04	28.42	24.83	21.0	26.83	27.21	24.54	20.7	25.36	25.74	24.28	20.5	24.01	24.39	25.19	21.7
	kW	21.32	21.30	21.26	21.4	23.73	23.71	23.67	23.9	26.42	26.40	26.36	26.5	29.33	29.31	29.27	29.5	32.58	32.56	32.52	32.7	36.40	36.38	36.34	36.5
	Hi PR	288	289	291	296	331	333	335	339	377	379	381	385	427	428	430	435	480	481	483	488	537	538	540	545
	Lo PR	130	131	134	139	137	138	141	147	143	145	148	153	149	150	153	158	154	156	159	164	161	162	167	170

IDB: Entering Indoor Dry Bulb Temperature Shaded area reflects ACCA (TVA) conditions High and low pressures are measured at the liquid and suction access fittings.

DSC1803W HIGH STATIC						
SPEED TAP	STATIC	AIRFLOW	RPM 1	RPM 2	BHP 1	BHP 2
T1*	0.2	2070	436	436	0.17	0.17
	0.4	1373	539	536	0.21	0.21
	0.6	999.7	604	614	0.24	0.24
	0.8	-	-	-	-	-
	1	-	-	-	-	-
	1.2	-	-	-	-	-
	1.4	-	-	-	-	-
	1.6	-	-	-	-	-
	1.8	-	-	-	-	-
	2	-	-	-	-	-
2.2	-	-	-	-	-	
T2*	0.2	2121	441	447	0.18	0.18
	0.4	1357	528	551	0.21	0.22
	0.6	1035	608	616	0.24	0.25
	0.8	-	-	-	-	-
	1	-	-	-	-	-
	1.2	-	-	-	-	-
	1.4	-	-	-	-	-
	1.6	-	-	-	-	-
	1.8	-	-	-	-	-
	2	-	-	-	-	-
2.2	-	-	-	-	-	
T3	0.2	6518	631	640	0.72	0.73
	0.4	6166	686	706	0.78	0.81
	0.6	5853	741	764	0.85	0.87
	0.8	5478	803	825	0.92	0.94
	1	4895	863	890	0.99	1.02
	1.2	4431	923	952	1.05	1.09
	1.4	4051	987	985	1.13	1.13
	1.6	3388	1052	1063	1.20	1.21
	1.8	2974	1087	1100	1.24	1.26
	2	2544	1124	1132	1.28	1.29
2.2	2174	1153	1160	1.32	1.33	
T4	0.2	9407	785	781	0.86	0.86
	0.4	9046	821	818	0.90	0.90
	0.6	8725	857	855	0.94	0.94
	0.8	8393	895	893	0.98	0.98
	1	8084	930	927	1.02	1.02
	1.2	7749	966	963	1.06	1.06
	1.4	7302	1015	1004	1.11	1.10
	1.6	6860	1058	1045	1.16	1.15
	1.8	6409	1105	1084	1.21	1.19
	2	5980	1146	1124	1.26	1.23
2.2	5493	1191	1164	1.31	1.28	

DSC1803W HIGH STATIC						
SPEED TAP	STATIC	AIRFLOW	RPM 1	RPM 2	BHP 1	BHP 2
T5	0.2	9342	815	810	1.22	1.21
	0.4	9023	850	847	1.27	1.26
	0.6	8740	885	883	1.32	1.32
	0.8	8449	922	919	1.37	1.37
	1	8181	955	951	1.42	1.42
	1.2	7896	989	986	1.47	1.47
	1.4	7575	1027	1021	1.53	1.52
	1.6	7205	1067	1058	1.59	1.58
	1.8	6812	1113	1095	1.66	1.63
	2	6446	1154	1133	1.72	1.69
T6	2.2	6010	1200	1172	1.79	1.75
	0.2	8791	766	775	1.43	1.45
	0.4	8453	824	837	1.54	1.56
	0.6	8175	870	888	1.63	1.66
	0.8	7911	912	938	1.71	1.75
	1	7640	950	981	1.78	1.83
	1.2	7386	986	1016	1.84	1.90
	1.4	7118	1028	1058	1.92	1.98
	1.6	6582	1082	1117	2.02	2.09
	1.8	6206	1124	1158	2.10	2.16
T7	2	5852	1172	1210	2.19	2.26
	2.2	5455	1234	1241	2.31	2.32
	0.2	9167	790	803	1.59	1.62
	0.4	8822	848	863	1.71	1.74
	0.6	8546	902	912	1.82	1.84
	0.8	8276	937	963	1.89	1.94
	1	8015	973	1005	1.96	2.02
	1.2	7756	1010	1042	2.03	2.10
	1.4	7462	1047	1082	2.11	2.18
	1.6	7177	1092	1119	2.20	2.25
T8	1.8	6673	1138	1177	2.29	2.37
	2	6364	1182	1218	2.38	2.45
	2.2	5961	1228	1267	2.47	2.55
	0.2	9536	816	828	1.77	1.79
	0.4	9212	870	885	1.89	1.92
	0.6	8934	913	932	1.98	2.02
	0.8	8680	955	977	2.07	2.12
	1	8445	990	1016	2.15	2.20
	1.2	8170	1024	1056	2.22	2.29
	1.4	7938	1060	1093	2.30	2.37
T8	1.6	7669	1101	1130	2.39	2.45
	1.8	7185	1150	1150	2.49	2.49
	2	6823	1187	1227	2.57	2.66
	2.2	6527	1231	1269	2.67	2.75

Shaded speed tap- Airflow for supplemental heat.

** (T1) and (T2) are part load only

DSC1803W HIGH STATIC						
SPEED TAP	STATIC	AIRFLOW	RPM 1	RPM 2	BHP 1	BHP 2
T9	0.2	9916	836	849	1.95	1.98
	0.4	9546	892	912	2.08	2.13
	0.6	9271	936	954	2.18	2.22
	0.8	9036	977	1000	2.28	2.33
	1	8766	1013	1043	2.36	2.43
	1.2	8527	1044	1080	2.43	2.52
	1.4	8295	1092	1117	2.55	2.60
	1.6	8073	1115	1148	2.60	2.68
	1.8	7832	1153	1185	2.69	2.76
	2	7291	1200	1240	2.80	2.89
T10	2.2	6979	1239	1276	2.89	2.97
	0.2	10290	859	872	2.15	2.18
	0.4	9974	913	927	2.29	2.32
	0.6	9693	957	974	2.40	2.44
	0.8	9455	996	1017	2.49	2.55
	1	9222	1030	1058	2.58	2.65
	1.2	8986	1063	1098	2.66	2.75
	1.4	8736	1097	1132	2.75	2.84
	1.6	8530	1127	1163	2.82	2.91
	1.8	8305	1163	1197	2.91	3.00
2	8016	1199	1231	3.00	3.08	
2.2	7453	1246	1284	3.12	3.22	

Shaded speed tap- Airflow for supplemental heat.

** (T1) and (T2) are part load only

DSC240W - HIGH STATIC						
SPEED TAP	STATIC	AIRFLOW	RPM 1	RPM 2	BHP 1	BHP 2
T1*	0.2	6492	631	620	0.71	0.70
	0.4	6091	702	733	0.79	0.83
	0.6	5741	764	793	0.86	0.89
	0.8	5160	862	847	0.97	0.95
	1	4674	906	931	1.02	1.05
	1.2	4316	953	985	1.07	1.11
	1.4	3992	999	1027	1.13	1.16
	1.6	3577	1052	1070	1.19	1.21
	1.8	3116	1100	1100	1.24	1.24
	2	2667	1137	1153	1.28	1.30
T2*	2.2	2195	1164	1185	1.31	1.34
	0.2	6962	666	697	0.83	0.87
	0.4	6573	729	761	0.91	0.95
	0.6	6187	787	819	0.98	1.02
	0.8	5633	874	881	1.09	1.10
	1	5273	921	936	1.15	1.17
	1.2	4783	976	1004	1.22	1.25
	1.4	4477	1018	1053	1.27	1.32
	1.6	4148	1061	1092	1.33	1.36
	1.8	3728	1115	1134	1.39	1.42
T3	2	3292	1158	1174	1.45	1.47
	2.2	2850	1193	1214	1.49	1.52
	0.2	9902	842	879	1.91	1.99
	0.4	9514	897	897	2.04	2.04
	0.6	9220	940	940	2.13	2.13
	0.8	8949	978	1019	2.22	2.31
	1	8695	1017	1060	2.31	2.41
	1.2	8415	1054	1098	2.39	2.49
	1.4	8158	1091	1136	2.48	2.58
	1.6	7604	1163	1184	2.64	2.69
T4	1.8	7336	1222	1205	2.77	2.73
	2	7034	1247	1244	2.83	2.82
	2.2	6667	1276	1306	2.90	2.96
	0.2	11001	820	859	1.81	1.90
	0.4	10606	873	909	1.93	2.01
	0.6	10247	916	954	2.02	2.11
	0.8	9983	952	994	2.10	2.20
	1	9713	987	1033	2.18	2.28
	1.2	9445	1026	1070	2.27	2.36
	1.4	9169	1062	1108	2.35	2.45
T4	1.6	8892	1095	1143	2.42	2.53
	1.8	8261	1169	1183	2.58	2.61
	2	8010	1222	1207	2.70	2.67
	2.2	7698	1242	1259	2.74	2.78

DSC240W - HIGH STATIC						
SPEED TAP	STATIC	AIRFLOW	RPM 1	RPM 2	BHP 1	BHP 2
T5	0.2	11135	830	872	2.03	2.13
	0.4	10732	888	926	2.17	2.27
	0.6	10412	930	969	2.28	2.37
	0.8	10166	964	1008	2.36	2.47
	1	9895	1000	1046	2.45	2.56
	1.2	9640	1036	1082	2.54	2.65
	1.4	9397	1076	1116	2.63	2.73
	1.6	9119	1104	1153	2.70	2.82
	1.8	8865	1138	1188	2.79	2.91
	2	8254	1221	1219	2.99	2.98
	2.2	8010	1262	1250	3.09	3.06
T6	0.2	9125	822	779	1.74	1.65
	0.4	8832	860	821	1.82	1.74
	0.6	8546	898	852	1.90	1.80
	0.8	8348	935	901	1.98	1.91
	1	8158	964	958	2.04	2.03
	1.2	7887	998	1007	2.11	2.13
	1.4	7592	1029	1063	2.18	2.25
	1.6	7272	1072	1109	2.27	2.35
	1.8	-	-	-	-	-
	2	-	-	-	-	-
	2.2	-	-	-	-	
T7	0.2	9412	852	805	1.91	1.81
	0.4	9124	888	845	1.99	1.90
	0.6	8851	925	874	2.08	1.96
	0.8	8663	960	920	2.15	2.06
	1	8490	987	976	2.22	2.19
	1.2	8232	1020	1024	2.29	2.30
	1.4	7947	1050	1079	2.36	2.42
	1.6	7646	1090	1124	2.45	2.52
	1.8	7366	1129	1155	2.53	2.59
	2	7134	1168	1186	2.62	2.66
	2.2	-	-	-	-	
T8	0.2	9695	885	834	2.10	1.98
	0.4	9412	919	871	2.19	2.07
	0.6	9153	954	897	2.27	2.13
	0.8	8974	988	942	2.35	2.24
	1	8814	1013	995	2.41	2.37
	1.2	8568	1045	1042	2.48	2.48
	1.4	8293	1073	1095	2.55	2.60
	1.6	8010	1111	1140	2.64	2.71
	1.8	7743	1148	1170	2.73	2.78
	2	7518	1186	1201	2.82	2.86
	2.2	7200	1223	1229	2.91	2.92

Shaded speed tap- Airflow for supplemental heat.

** (T1) and (T2) are part load only

DSC240W - HIGH STATIC						
SPEED TAP	STATIC	AIRFLOW	RPM 1	RPM 2	BHP 1	BHP 2
T9	0.2	9881	909	854	2.30	2.16
	0.4	9602	941	890	2.38	2.25
	0.6	9353	976	915	2.46	2.31
	0.8	9179	1008	959	2.55	2.42
	1	9025	1032	1009	2.61	2.55
	1.2	8787	1063	1055	2.68	2.66
	1.4	8519	1090	1107	2.75	2.80
	1.6	8248	1127	1151	2.85	2.91
	1.8	7989	1163	1181	2.94	2.98
	2	7770	1199	1211	3.03	3.06
	2.2	7460	1237	1239	3.12	3.13
T10	0.2	10268	963	902	2.58	2.41
	0.4	9996	993	935	2.66	2.50
	0.6	9769	1025	957	2.74	2.56
	0.8	9604	1055	997	2.82	2.67
	1	9456	1077	1042	2.88	2.79
	1.2	9235	1106	1084	2.96	2.90
	1.4	8983	1132	1133	3.03	3.03
	1.6	8736	1164	1175	3.11	3.14
	1.8	8496	1197	1204	3.20	3.22
	2	8288	1232	1233	3.29	3.30
	2.2	8001	1267	1259	3.39	3.37

Shaded speed tap- Airflow for supplemental heat.

** (T1) and (T2) are part load only

DSC3003W HIGH STATIC						
SPEED TAP	STATIC	AIRFLOW	RPM 1	RPM 2	BHP 1	BHP 2
T1*	0.2	7629	701	674	1.07	1.03
	0.4	7314	746	725	1.14	1.11
	0.6	6969	789	777	1.21	1.19
	0.8	6701	833	829	1.28	1.27
	1	6380	882	892	1.35	1.37
	1.2	6049	919	939	1.41	1.44
	1.4	5706	956	994	1.46	1.52
	1.6	5285	1010	1035	1.55	1.58
	1.8	4952	1055	1066	1.62	1.63
	2	4673	1094	1098	1.68	1.68
T2*	2.2	4339	1128	1134	1.73	1.74
	0.2	7900	719	690	1.17	1.12
	0.4	7588	763	739	1.24	1.20
	0.6	7253	805	787	1.31	1.28
	0.8	6999	848	839	1.38	1.37
	1	6706	893	902	1.45	1.47
	1.2	6386	929	949	1.51	1.55
	1.4	6051	966	1005	1.57	1.64
	1.6	5649	1018	1048	1.66	1.71
	1.8	5322	1063	1079	1.73	1.76
T3	2	5050	1102	1111	1.79	1.81
	2.2	4712	1137	1146	1.85	1.87
	0.2	9468	859	811	1.95	1.84
	0.4	9181	894	850	2.03	1.93
	0.6	8911	930	878	2.11	1.99
	0.8	8724	966	925	2.19	2.10
	1	8554	992	980	2.25	2.22
	1.2	8298	1025	1027	2.33	2.33
	1.4	8015	1054	1082	2.39	2.45
	1.6	7718	1094	1128	2.48	2.56
T4	1.8	7441	1133	1158	2.57	2.63
	2	7210	1171	1189	2.66	2.70
	2.2	6884	1209	1218	2.74	2.76
	0.2	12723	972	914	2.75	2.58
	0.4	12364	1007	952	2.84	2.69
	0.6	12043	1044	979	2.95	2.77
	0.8	11819	1078	1026	3.04	2.90
	1	11621	1104	1079	3.12	3.05
	1.2	11315	1137	1129	3.21	3.19
	1.4	10969	1166	1184	3.29	3.35
T4	1.6	10620	1206	1231	3.41	3.48
	1.8	10287	1244	1263	3.52	3.57
	2	10005	1283	1295	3.62	3.66
	2.2	9606	1323	1325	3.74	3.75

DSC3003W HIGH STATIC						
SPEED TAP	STATIC	AIRFLOW	RPM 1	RPM 2	BHP 1	BHP 2
T5	0.2	12849	1012	948	2.99	2.80
	0.4	12509	1044	983	3.09	2.91
	0.6	12223	1078	1006	3.18	2.98
	0.8	12017	1109	1048	3.28	3.10
	1	11831	1131	1095	3.34	3.24
	1.2	11553	1163	1141	3.44	3.37
	1.4	11237	1190	1191	3.52	3.52
	1.6	10927	1224	1236	3.62	3.66
	1.8	10626	1258	1266	3.72	3.74
	2	10366	1295	1297	3.83	3.84
T6	0.2	10005	1333	1325	3.94	3.92
	0.2	10268	963	902	2.58	2.41
	0.4	9996	993	935	2.66	2.50
	0.6	9769	1025	957	2.74	2.56
	0.8	9604	1055	997	2.82	2.67
	1	9456	1077	1042	2.88	2.79
	1.2	9235	1106	1084	2.96	2.90
	1.4	8983	1132	1133	3.03	3.03
	1.6	8736	1164	1175	3.11	3.14
	1.8	8496	1197	1204	3.20	3.22
T7	2	8288	1232	1233	3.29	3.30
	2.2	8001	1267	1259	3.39	3.37
	0.2	10626	1022	955	2.95	2.75
	0.4	10361	1049	984	3.03	2.84
	0.6	10156	1080	1004	3.11	2.90
	0.8	9995	1107	1040	3.19	3.00
	1	9842	1127	1079	3.25	3.11
	1.2	9638	1155	1117	3.33	3.22
	1.4	9402	1179	1160	3.40	3.35
	1.6	9176	1207	1199	3.48	3.46
T8	1.8	8958	1236	1227	3.57	3.54
	2	8760	1269	1255	3.66	3.62
	2.2	8502	1302	1280	3.76	3.69
	0.2	10979	1092	1017	3.41	3.17
	0.4	10723	1116	1042	3.48	3.25
	0.6	10544	1144	1062	3.57	3.31
	0.8	10382	1168	1093	3.65	3.41
	1	10209	1190	1123	3.71	3.51
	1.2	10023	1216	1155	3.79	3.60
	1.4	9804	1237	1191	3.86	3.72
T8	1.6	9598	1261	1225	3.93	3.82
	1.8	9406	1285	1252	4.01	3.91
	2	9218	1314	1278	4.10	3.99
	2.2	9000	1344	1301	4.19	4.06

Shaded speed tap- Airflow for supplemental heat.

** (T1) and (T2) are part load only

DSC3003W HIGH STATIC						
SPEED TAP	STATIC	AIRFLOW	RPM 1	RPM 2	BHP 1	BHP 2
T9	0.2	11348	1185	1101	4.05	3.76
	0.4	11101	1206	1120	4.11	3.82
	0.6	10956	1230	1142	4.20	3.90
	0.8	10785	1250	1165	4.27	3.97
	1	10567	1275	1183	4.35	4.04
	1.2	10402	1298	1205	4.43	4.11
	1.4	10203	1317	1230	4.49	4.20
	1.6	10015	1335	1257	4.56	4.29
	1.8	9858	1353	1281	4.62	4.37
	2	9682	1376	1305	4.70	4.45
T10	2.2	9524	1400	1326	4.78	4.52
	0.2	11679	1301	1205	4.88	4.52
	0.4	11444	1317	1219	4.94	4.57
	0.6	11337	1338	1246	5.02	4.67
	0.8	11145	1353	1257	5.07	4.71
	1	10847	1386	1260	5.20	4.72
	1.2	10703	1405	1267	5.27	4.75
	1.4	10526	1421	1277	5.33	4.79
	1.6	10353	1432	1291	5.37	4.84
	1.8	10238	1441	1313	5.40	4.93
2	10074	1457	1333	5.47	5.00	
2.2	10002	1473	1353	5.52	5.07	

Shaded speed tap- Airflow for supplemental heat.

** (T1) and (T2) are part load only

DSC1803D STANDARD STATIC						
SPEED TAP	STATIC	AIRFLOW	RPM 1	RPM 2	BHP 1	BHP 2
T1*	0.2	2489	442	436	0.17	0.17
	0.4	1540	561	560	0.21	0.21
	0.6	1029	619	620	0.24	0.24
	0.8	492	678	677	0.26	0.26
	1	-	-	-	-	-
	1.2	-	-	-	-	-
T2*	0.2	4085	494	499	0.34	0.35
	0.4	3417	619	583	0.43	0.41
	0.6	2773	680	683	0.47	0.48
	0.8	1974	752	750	0.52	0.52
	1	1492	797	795	0.55	0.55
	1.2	1243	844	841	0.59	0.59
T3	0.2	4888	533	540	0.49	0.50
	0.4	4424	609	619	0.56	0.57
	0.6	3767	721	685	0.66	0.63
	0.8	3225	772	773	0.71	0.71
	1	2608	837	833	0.77	0.76
	1.2	2005	886	883	0.81	0.81
T4	0.2	7235	661	674	1.24	1.27
	0.4	6874	729	738	1.37	1.39
	0.6	6579	788	797	1.48	1.50
	0.8	6301	835	846	1.57	1.59
	1	6023	881	895	1.65	1.68
	1.2	5436	986	940	1.85	1.77
T5	0.2	8207	665	678	1.34	1.37
	0.4	7783	737	747	1.49	1.51
	0.6	7436	793	802	1.60	1.62
	0.8	7098	845	857	1.70	1.73
	1	6725	896	909	1.81	1.83
	1.2	6023	1002	956	2.02	1.93
T6	0.2	6824	633	644	1.04	1.06
	0.4	6489	700	710	1.15	1.16
	0.6	6119	758	767	1.24	1.26
	0.8	5803	809	820	1.33	1.35
	1	5187	916	869	1.50	1.43
	1.2	4817	964	926	1.58	1.52
T7	0.2	7041	640	653	1.10	1.13
	0.4	6682	709	719	1.22	1.24
	0.6	6354	768	777	1.33	1.34
	0.8	6035	819	830	1.41	1.43
	1	5470	917	879	1.58	1.52
	1.2	5111	971	925	1.68	1.60
T8	0.2	7291	650	663	1.19	1.21
	0.4	6936	719	728	1.32	1.33
	0.6	6604	778	786	1.42	1.44
	0.8	6311	828	840	1.51	1.54
	1	5998	877	890	1.60	1.63
	1.2	5388	980	935	1.79	1.71
T9	0.2	7399	656	669	1.23	1.26
	0.4	7019	725	734	1.36	1.38
	0.6	7138	800	815	1.50	1.53
	0.8	6826	843	851	1.59	1.60
	1	6501	888	888	1.67	1.67
	1.2	6149	942	928	1.77	1.74
T10	0.2	7700	719	739	1.39	1.42
	0.4	7502	764	782	1.47	1.51
	0.6	7247	805	821	1.55	1.58
	0.8	6941	848	857	1.63	1.65
	1	6620	892	893	1.72	1.72
	1.2	6275	946	932	1.82	1.80

Shaded speed tap- Airflow for supplemental heat.

** (T1) and (T2) are part load only

DSC2403D STANDARD STATIC						
SPEED TAP	STATIC	AIRFLOW	RPM 1	RPM 2	BHP 1	BHP 2
T1*	0.2	4329	529	538	0.30	0.31
	0.4	3748	613	632	0.35	0.36
	0.6	3175	698	713	0.40	0.41
	0.8	2598	765	776	0.44	0.45
	1	1961	826	824	0.48	0.47
	1.2	1581	861	858	0.50	0.49
T2*	0.2	6131	630	641	0.66	0.67
	0.4	5728	698	709	0.73	0.75
	0.6	5383	751	766	0.79	0.81
	0.8	4875	824	839	0.87	0.88
	1	4430	881	903	0.93	0.95
	1.2	4032	933	953	0.98	1.00
T3	0.2	7378	770	720	1.14	1.07
	0.4	7012	770	779	1.14	1.15
	0.6	6713	819	832	1.21	1.23
	0.8	6434	862	879	1.28	1.30
	1	6147	907	928	1.34	1.37
	1.2	5641	968	994	1.43	1.47
T4	0.2	9035	831	853	2.04	2.09
	0.4	8705	885	905	2.17	2.22
	0.6	8441	931	949	2.28	2.33
	0.8	8214	972	986	2.38	2.42
	1	8010	1008	1024	2.47	2.51
	1.2	7817	1037	1057	2.54	2.59
T5	0.2	9243	853	876	2.19	2.25
	0.4	8881	909	928	2.33	2.38
	0.6	8628	954	971	2.45	2.49
	0.8	8428	991	1006	2.54	2.58
	1	8219	1027	1042	2.64	2.68
	1.2	8010	1058	1077	2.72	2.76
T6	0.2	8648	779	797	1.53	1.56
	0.4	8257	839	853	1.64	1.67
	0.6	7965	884	897	1.73	1.76
	0.8	7705	928	943	1.82	1.85
	1	7445	966	984	1.89	1.93
	1.2	7209	1002	1024	1.96	2.01
T7	0.2	9025	801	820	1.71	1.75
	0.4	8641	862	877	1.84	1.87
	0.6	8368	908	921	1.94	1.97
	0.8	8107	952	965	2.03	2.06
	1	7863	986	1003	2.10	2.14
	1.2	7616	1023	1043	2.18	2.23
T8	0.2	9429	837	846	1.94	1.96
	0.4	9073	885	900	2.05	2.09
	0.6	8768	931	945	2.16	2.19
	0.8	8508	972	987	2.26	2.29
	1	8261	1007	1024	2.34	2.38
	1.2	8052	1043	1064	2.42	2.47
T9	0.2	9997	863	886	2.26	2.32
	0.4	9632	919	940	2.40	2.46
	0.6	9340	967	985	2.53	2.57
	0.8	9089	1009	1024	2.64	2.68
	1	8863	1047	1063	2.74	2.78
	1.2	8649	1077	1098	2.81	2.87
T10	0.2	10340	881	905	2.45	2.52
	0.4	9935	939	958	2.61	2.66
	0.6	9652	986	1003	2.74	2.79
	0.8	9429	1024	1039	2.85	2.89
	1	9195	1061	1077	2.95	2.99
	1.2	8961	1093	1112	3.04	3.09

Shaded speed tap- Airflow for supplemental heat.

** (T1) and (T2) are part load only

DSC3003D STANDARD STATIC						
SPEED TAP	STATIC	AIRFLOW	RPM 1	RPM 2	BHP 1	BHP 2
T1*	0.2	5677	764	679	0.75	0.67
	0.4	5447	804	725	0.79	0.71
	0.6	5218	844	773	0.83	0.76
	0.8	4937	883	822	0.87	0.81
	1	4689	923	867	0.91	0.85
	1.2	4376	963	914	0.95	0.90
T2*	0.2	6841	842	753	1.14	1.02
	0.4	6594	790	874	1.07	1.19
	0.6	6555	802	881	1.09	1.20
	0.8	6377	907	836	1.23	1.13
	1	6174	941	872	1.28	1.18
	1.2	5651	1007	959	1.37	1.30
T3	0.2	7993	996	879	1.78	1.57
	0.4	7824	1024	913	1.83	1.63
	0.6	7646	1052	946	1.88	1.69
	0.8	7489	1079	976	1.92	1.74
	1	7307	1104	1007	1.97	1.80
	1.2	7131	1133	1043	2.02	1.86
T4	0.2	10787	1065	993	3.14	2.92
	0.4	10524	1091	1020	3.21	3.01
	0.6	10331	1120	1040	3.30	3.07
	0.8	10170	1147	1075	3.38	3.17
	1	10010	1167	1112	3.44	3.28
	1.2	9814	1194	1147	3.52	3.38
T5	0.2	10969	1086	1011	3.38	3.15
	0.4	10712	1110	1036	3.46	3.23
	0.6	10532	1138	1056	3.54	3.29
	0.8	10369	1162	1087	3.62	3.38
	1	10197	1183	1118	3.69	3.48
	1.2	10010	1209	1150	3.76	3.58
T6	0.2	9218	832	787	1.79	1.70
	0.4	8927	869	828	1.87	1.79
	0.6	-	-	-	-	-
	0.8	-	-	-	-	-
	1	-	-	-	-	-
	1.2	-	-	-	-	-
T7	0.2	9642	879	828	2.07	1.95
	0.4	9358	913	866	2.15	2.04
	0.6	9096	949	893	2.23	2.10
	0.8	8916	983	938	2.31	2.21
	1	8754	1008	991	2.37	2.33
	1.2	-	-	-	-	-
T8	0.2	9934	1083	971	2.68	2.40
	0.4	9735	1110	999	2.75	2.47
	0.6	9559	1138	1027	2.82	2.54
	0.8	9379	1162	1056	2.88	2.61
	1	9201	1187	1086	2.94	2.69
	1.2	9006	1212	1120	3.00	2.77
T9	0.2	10398	1123	1008	3.04	2.73
	0.4	10203	1149	1034	3.11	2.80
	0.6	10034	1176	1060	3.18	2.87
	0.8	9863	1199	1087	3.24	2.94
	1	9698	1222	1116	3.30	3.02
	1.2	9516	1245	1147	3.37	3.10
T10	0.2	10958	1088	1013	3.38	3.15
	0.4	10701	1112	1038	3.45	3.22
	0.6	10521	1140	1058	3.54	3.29
	0.8	10359	1164	1089	3.61	3.38
	1	10187	1186	1120	3.68	3.48
	1.2	10000	1211	1152	3.76	3.58

Shaded speed tap- Airflow for supplemental heat.

** (T1) and (T2) are part load only

MODELS: DSC1803D, DSC1804D, DSC1807D • STANDARD STATIC TO 3.5HP (0.2~1.2 ESP)															
CFM	0.2					0.4					0.6				
	RPM1	RPM2	DDC%	BHP1	BHP2	RPM1	RPM2	DDC%	BHP1	BHP2	RPM1	RPM2	DDC%	BHP1	BHP2
3600	449	462	27	0.36	0.38	554	551	29	0.41	0.41	667	640	31	0.52	0.50
3900	468	480	28	0.36	0.37	568	568	30	0.43	0.43	674	652	32	0.54	0.52
4200	486	499	29	0.37	0.38	583	584	31	0.45	0.46	682	665	33	0.58	0.56
4500	505	518	30	0.39	0.40	598	601	32	0.49	0.50	691	678	34	0.63	0.61
4800	523	537	32	0.42	0.44	613	618	34	0.54	0.55	700	692	36	0.69	0.68
5100	542	556	33	0.47	0.48	628	635	35	0.60	0.61	710	706	38	0.76	0.75
5400	561	575	35	0.52	0.54	644	652	37	0.67	0.68	721	721	40	0.84	0.84
5700	579	595	37	0.59	0.60	660	670	39	0.76	0.77	733	736	42	0.93	0.94
6000	598	614	39	0.67	0.68	676	687	42	0.85	0.86	745	751	44	1.04	1.05
6300	617	634	41	0.76	0.77	693	705	44	0.96	0.97	758	767	47	1.15	1.17
6600	636	653	43	0.86	0.88	709	724	47	1.07	1.09	772	784	50	1.28	1.30
CFM	0.8					1					1.2				
	RPM1	RPM2	DDC%	BHP1	BHP2	RPM1	RPM2	DDC%	BHP1	BHP2	RPM1	RPM2	DDC%	BHP1	BHP2
3600	758	745	36	0.76	0.75	798	784	34	0.74	0.71	861	855	37	0.90	0.87
3900	756	742	36	0.74	0.73	808	791	36	0.80	0.77	872	861	38	0.98	0.95
4200	756	741	36	0.74	0.72	817	800	37	0.87	0.84	883	868	40	1.06	1.03
4500	758	742	36	0.76	0.74	827	809	39	0.94	0.91	893	876	42	1.15	1.12
4800	761	745	37	0.79	0.77	836	819	41	1.03	1.00	904	884	44	1.25	1.22
5100	765	750	38	0.84	0.82	846	829	43	1.13	1.10	913	892	46	1.36	1.33
5400	772	758	39	0.91	0.89	856	840	45	1.23	1.21	923	902	49	1.48	1.44
5700	779	767	41	0.99	0.98	866	852	48	1.35	1.33	932	912	51	1.60	1.57
6000	789	778	43	1.10	1.09	875	865	50	1.47	1.46	941	922	54	1.73	1.71
6300	800	792	46	1.22	1.22	885	878	53	1.61	1.61	949	934	57	1.87	1.86
6600	812	807	48	1.36	1.36	895	892	56	1.75	1.76	957	946	60	2.02	2.01

MODELS: DSC2403D, DSC2404D, DSC2407D • STANDARD STATIC TO 3.5HP (0.2 ~1.2 ESP)															
CFM	0.2					0.4					0.6				
	RPM1	RPM2	DDC%	BHP1	BHP2	RPM1	RPM2	DDC%	BHP1	BHP2	RPM1	RPM2	DDC%	BHP1	BHP2
4800	525	539	31	0.42	1.18	615	621	33	0.53	1.07	699	693	35	0.66	1.05
5200	550	566	33	0.48	1.17	635	644	35	0.61	1.07	712	712	37	0.75	1.05
5600	576	593	35	0.56	1.16	656	668	38	0.71	1.06	726	731	40	0.86	1.04
6000	601	620	38	0.65	1.15	678	691	40	0.82	1.05	742	752	43	1.00	1.03
6400	627	646	41	0.77	1.14	700	715	44	0.96	1.04	759	773	46	1.15	1.02
6800	652	672	44	0.91	1.13	722	739	47	1.12	1.03	778	794	50	1.32	1.01
7200	677	698	48	1.06	1.12	744	763	51	1.30	1.03	798	817	54	1.52	1.01
7600	702	724	52	1.24	1.11	767	788	55	1.49	1.02	819	840	59	1.73	1.00
8000	727	750	56	1.43	1.11	791	812	60	1.71	1.01	842	865	64	1.97	0.99
8400	752	775	61	1.65	1.10	814	836	65	1.95	1.00	867	890	69	2.22	0.99
8800	777	800	66	1.88	1.09	838	861	70	2.21	0.99	892	915	74	2.50	0.98
CFM	0.8					1					1.2				
	RPM1	RPM2	DDC%	BHP1	BHP2	RPM1	RPM2	DDC%	BHP1	BHP2	RPM1	RPM2	DDC%	BHP1	BHP2
4800	777	761	37	0.84	0.92	860	820	40	1.05	0.75	908	884	43	1.22	0.71
5200	791	776	40	0.95	0.91	874	834	43	1.18	0.75	920	896	46	1.36	0.71
5600	806	792	43	1.08	0.91	888	849	46	1.32	0.74	932	908	49	1.51	0.70
6000	821	809	46	1.23	0.90	900	866	49	1.48	0.74	944	922	52	1.68	0.70
6400	836	828	50	1.39	0.89	911	883	53	1.65	0.74	954	937	56	1.87	0.70
6800	852	848	53	1.57	0.89	922	902	57	1.84	0.73	964	953	60	2.07	0.70
7200	868	869	58	1.78	0.88	931	921	61	2.04	0.73	973	971	64	2.28	0.69
7600	885	892	62	2.00	0.88	939	942	66	2.26	0.72	981	989	69	2.50	0.69
8000	902	915	67	2.23	0.87	947	964	71	2.49	0.72	989	1009	74	2.74	0.69
8400	919	940	72	2.49	0.87										
8800															

MODELS: DSC3003D, DSC3004D, DSC3007D • STANDARD STATIC TO 5HP (0.2 ~1.2 ESP)															
CFM	0.2					0.4					0.6				
	RPM1	RPM2	DDC%	BHP1	BHP2	RPM1	RPM2	DDC%	BHP1	BHP2	RPM1	RPM2	DDC%	BHP1	BHP2
7000	648	629	25	0.76	0.75	715	699	28	0.93	0.91	781	767	31	1.13	1.11
7500	680	656	29	0.92	0.89	748	726	33	1.12	1.09	816	792	36	1.35	1.32
8000	719	689	35	1.13	1.09	788	760	38	1.37	1.32	857	823	42	1.62	1.56
8500	765	730	40	1.40	1.33	835	800	44	1.66	1.59	904	859	48	1.94	1.84
9000	819	777	47	1.72	1.63	889	847	51	2.01	1.91	957	902	54	2.29	2.17
9500	880	830	54	2.10	1.97	950	899	58	2.41	2.27	1015	952	61	2.70	2.53
10000	949	891	61	2.53	2.37	1018	958	65	2.86	2.68	1079	1007	68	3.14	2.93
10500	1025	958	69	3.01	2.81	1093	1023	73	3.36	3.14	1149	1069	76	3.63	3.38
11000	1109	1032	77	3.55	3.30	1175	1094	82	3.91	3.64	1225	1137	84	4.16	3.86
CFM	0.8					1					1.2				
	RPM1	RPM2	DDC%	BHP1	BHP2	RPM1	RPM2	DDC%	BHP1	BHP2	RPM1	RPM2	DDC%	BHP1	BHP2
7000	840	831	34	1.30	1.29	894	908	36	1.48	1.50	947	972	39	1.69	1.73
7500	874	856	39	1.54	1.51	925	933	41	1.73	1.74	979	996	44	1.96	1.98
8000	914	886	44	1.82	1.77	963	961	47	2.03	2.01	1018	1024	50	2.27	2.26
8500	959	922	50	2.15	2.06	1007	993	53	2.37	2.31	1062	1053	56	2.62	2.57
9000	1010	963	57	2.52	2.39	1058	1029	59	2.75	2.65	1112	1086	62	3.01	2.91
9500	1067	1009	64	2.93	2.76	1115	1069	66	3.18	3.02	1168	1121	69	3.44	3.28
10000	1129	1061	71	3.38	3.17	1179	1113	74	3.65	3.43	1230	1159	77	3.91	3.68
10500	1197	1118	79	3.88	3.62	1250	1161	82	4.16	3.88	1298	1200	84	4.41	4.11
11000	1270	1181	87	4.42	4.11	1328	1213	90	4.71	4.36					

MODELS: DSC1803W, DSC1804W, DSC1807W • HIGH STATIC TO 5HP (0.8 ~2.2 ESP)																				
CFM	0.8					1					1.2					1.4				
	RPM1	RPM2	DDC%	BHP1	BHP2	RPM1	RPM2	DDC%	BHP1	BHP2	RPM1	RPM2	DDC%	BHP1	BHP2	RPM1	RPM2	DDC%	BHP1	BHP2
4200	689	688	17	1.72	0.41	761	770	20	1.89	0.54	836	838	22	1.77	0.60	994	948	27	2.26	0.81
4500	704	704	18	1.71	0.41	774	782	21	1.87	0.54	846	847	23	1.76	0.61	990	949	28	2.25	0.82
4800	720	719	19	1.70	0.41	787	793	22	1.86	0.55	857	857	24	1.74	0.63	987	951	29	2.23	0.84
5100	736	735	21	1.68	0.44	801	805	23	1.85	0.57	868	867	26	1.73	0.67	985	955	30	2.22	0.87
5400	752	751	22	1.67	0.47	814	818	25	1.83	0.61	879	878	27	1.72	0.72	985	959	31	2.21	0.92
5700	768	767	24	1.66	0.52	829	831	27	1.82	0.66	891	889	29	1.71	0.78	986	965	32	2.19	0.99
6000	785	783	26	1.65	0.58	843	844	28	1.81	0.72	903	901	31	1.70	0.86	989	971	34	2.18	1.07
6300	801	799	28	1.63	0.66	858	858	30	1.79	0.80	916	913	33	1.68	0.96	992	978	36	2.16	1.16
6600	818	816	30	1.62	0.75	873	872	32	1.78	0.90	929	926	35	1.67	1.06	998	986	38	2.15	1.27
CFM	1.6					1.8					2					2.2				
	RPM1	RPM2	DDC%	BHP1	BHP2	RPM1	RPM2	DDC%	BHP1	BHP2	RPM1	RPM2	DDC%	BHP1	BHP2	RPM1	RPM2	DDC%	BHP1	BHP2
4200	1025	1009	29	1.82	0.90	1070	1049	30	1.36	0.99	1114	1095	32	1.10	1.13	1164	1140	34	0.77	1.29
4500	1024	1009	30	1.81	0.93	1073	1051	31	1.35	1.04	1119	1098	34	1.10	1.20	1170	1145	36	0.77	1.39
4800	1025	1010	31	1.79	0.97	1076	1054	33	1.34	1.11	1124	1101	35	1.09	1.28	1177	1150	38	0.77	1.49
5100	1027	1013	32	1.78	1.02	1080	1058	34	1.34	1.18	1129	1106	37	1.09	1.37	1183	1155	40	0.77	1.60
5400	1029	1016	33	1.77	1.09	1085	1062	36	1.33	1.27	1135	1111	38	1.09	1.47	1190	1161	41	0.77	1.72
5700	1033	1020	35	1.76	1.17	1090	1067	38	1.32	1.37	1141	1116	40	1.08	1.59	1196	1167	43	0.77	1.85
6000	1037	1025	37	1.75	1.26	1096	1073	40	1.32	1.49	1147	1122	42	1.08	1.71	1203	1173	45	0.77	1.98
6300	1043	1031	39	1.74	1.37	1102	1080	42	1.31	1.61	1153	1129	44	1.07	1.84	1209	1180	48	0.77	2.13
6600	1049	1038	41	1.73	1.50	1109	1088	44	1.30	1.75	1160	1136	47	1.07	1.99	1216	1187	50	0.76	2.29

MODELS: DSC2403W, DSC2404W, DSC2407W • HIGH STATIC TO 5HP (0.8 ~2.2 ESP)																				
CFM	0.8					1					1.2					1.4				
	RPM1	RPM2	DDC%	BHP1	BHP2	RPM1	RPM2	DDC%	BHP1	BHP2	RPM1	RPM2	DDC%	BHP1	BHP2	RPM1	RPM2	DDC%	BHP1	BHP2
5600	775	789	22	0.86	0.88	842	861	24	0.99	1.04	889	918	27	1.14	1.21	938	985	30	1.31	1.41
6000	789	797	25	0.95	0.97	852	871	27	1.10	1.14	901	931	30	1.26	1.33	953	999	33	1.46	1.55
6400	807	808	28	1.07	1.08	866	884	31	1.23	1.27	916	946	33	1.42	1.48	970	1015	36	1.63	1.72
6800	828	822	32	1.22	1.21	883	900	34	1.39	1.42	936	963	37	1.59	1.64	991	1032	40	1.82	1.90
7200	853	840	36	1.39	1.37	906	918	38	1.57	1.59	959	981	41	1.79	1.83	1015	1050	44	2.04	2.10
7600	882	861	40	1.59	1.56	932	938	42	1.79	1.79	987	1002	45	2.02	2.03	1043	1069	49	2.28	2.31
8000	914	886	44	1.82	1.77	963	961	47	2.03	2.01	1018	1024	50	2.27	2.26	1074	1090	53	2.54	2.54
8400	950	914	49	2.08	2.00	998	986	52	2.30	2.25	1052	1047	55	2.55	2.50	1108	1111	58	2.82	2.79
8800	989	946	54	2.36	2.26	1037	1014	57	2.59	2.51										
CFM	1.6					1.8					2					2.2				
	RPM1	RPM2	DDC%	BHP1	BHP2	RPM1	RPM2	DDC%	BHP1	BHP2	RPM1	RPM2	DDC%	BHP1	BHP2	RPM1	RPM2	DDC%	BHP1	BHP2
5600	1008	1042	33	1.54	1.63	1066	1086	36	1.75	1.82	1116	1129	38	1.94	1.98	1165	1175	41	2.16	2.19
6000	1023	1058	36	1.71	1.79	1081	1101	39	1.93	1.98	1132	1143	41	2.12	2.16	1182	1189	45	2.35	2.38
6400	1040	1074	40	1.89	1.97	1099	1117	43	2.12	2.17	1149	1159	45	2.32	2.35	1199	1203	48	2.56	2.57
6800	1060	1091	44	2.09	2.16	1118	1134	47	2.33	2.36	1168	1175	49	2.54	2.55	1219	1217	52	2.78	2.78
7200	1083	1108	48	2.31	2.36	1139	1150	51	2.56	2.57	1189	1191	53	2.77	2.77	1239	1232	56	3.02	2.99
7600	1109	1127	52	2.56	2.58	1163	1168	55	2.80	2.80	1212	1208	58	3.02	3.00	1261	1247	61	3.28	3.22
8000	1137	1146	57	2.82	2.82	1189	1186	60	3.06	3.03	1237	1225	62	3.29	3.24	1285	1262	65	3.55	3.46
8400																				
8800																				

MODELS: DSC3003W, DSC3004W, DSC3007W •STANDARD STATIC TO 5HP (0.8 ~2.2 ESP)																				
CFM	0.8					1					1.2					1.4				
	RPM1	RPM2	DDC%	BHP1	BHP2	RPM1	RPM2	DDC%	BHP1	BHP2	RPM1	RPM2	DDC%	BHP1	BHP2	RPM1	RPM2	DDC%	BHP1	BHP2
7000	840	831	34	1.30	1.29	894	908	36	1.48	1.50	947	972	39	1.69	1.73	1003	1041	42	1.93	2.00
7500	874	856	39	1.54	1.51	925	933	41	1.73	1.74	979	996	44	1.96	1.98	1036	1064	48	2.21	2.26
8000	914	886	44	1.82	1.77	963	961	47	2.03	2.01	1018	1024	50	2.27	2.26	1074	1090	53	2.54	2.54
8500	959	922	50	2.15	2.06	1007	993	53	2.37	2.31	1062	1053	56	2.62	2.57	1117	1117	59	2.90	2.86
9000	1010	963	57	2.52	2.39	1058	1029	59	2.75	2.65	1112	1086	62	3.01	2.91	1165	1146	66	3.29	3.20
9500	1067	1009	64	2.93	2.76	1115	1069	66	3.18	3.02	1168	1121	69	3.44	3.28	1218	1177	73	3.72	3.57
10000	1129	1061	71	3.38	3.17	1179	1113	74	3.65	3.43	1230	1159	77	3.91	3.68	1276	1209	80	4.18	3.96
10500	1197	1118	79	3.88	3.62	1250	1161	82	4.16	3.88	1298	1200	84	4.41	4.11	1340	1244	88	4.68	4.38
11000	1270	1181	87	4.42	4.11	1328	1213	90	4.71	4.36	1371	1243	93	4.96	4.58	1408	1280	96	5.21	4.82
CFM	1.6					1.8					2					2.2				
	RPM1	RPM2	DDC%	BHP1	BHP2	RPM1	RPM2	DDC%	BHP1	BHP2	RPM1	RPM2	DDC%	BHP1	BHP2	RPM1	RPM2	DDC%	BHP1	BHP2
7000	1072	1099	46	2.20	2.26	1128	1142	49	2.44	2.47	1179	1183	51	2.65	2.66	1229	1225	54	2.90	2.88
7500	1102	1122	51	2.50	2.52	1157	1164	54	2.74	2.74	1206	1203	56	2.96	2.94	1256	1243	59	3.21	3.16
8000	1137	1146	57	2.82	2.82	1189	1186	60	3.06	3.03	1237	1225	62	3.29	3.24	1285	1262	65	3.55	3.46
8500	1175	1171	63	3.18	3.13	1224	1210	65	3.42	3.35	1270	1247	68	3.65	3.56	1316	1282	71	3.90	3.78
9000	1218	1197	69	3.56	3.47	1262	1234	72	3.80	3.68	1306	1270	74	4.03	3.90	1350	1302	77	4.28	4.11
9500	1265	1224	76	3.98	3.83	1303	1260	78	4.21	4.04	1344	1294	81	4.45	4.26	1386	1323	83	4.69	4.46
10000	1316	1252	83	4.43	4.21	1348	1286	85	4.64	4.42	1386	1318	87	4.88	4.63	1424	1343	89	5.11	4.83
10500																				
11000																				

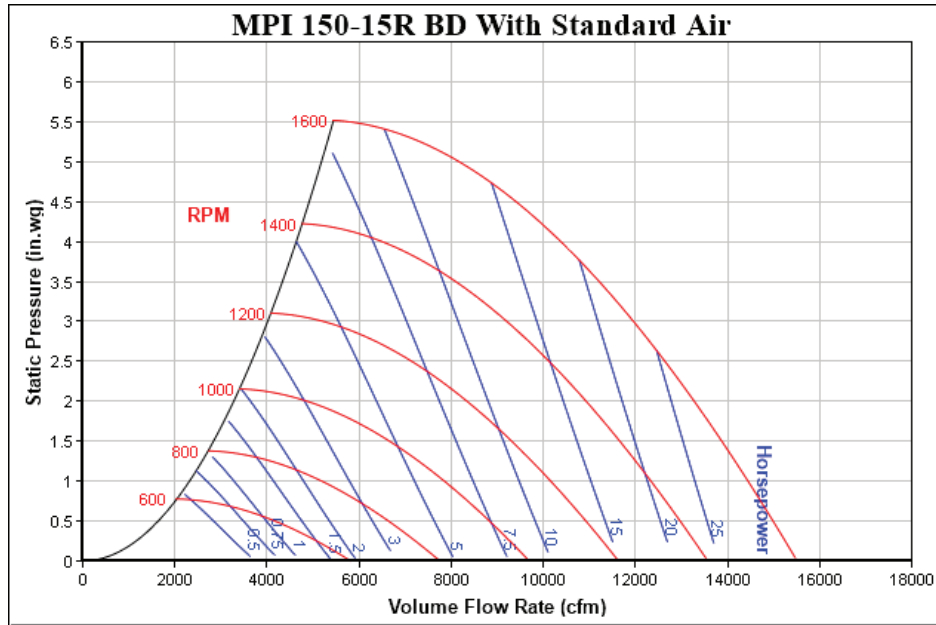

AIRFLOW PRESSURE DROP OF DOWNFLOW ECONOMIZER FOR 15 TO 25 TON ROOFTOP UNITS (100% RETURN AIR)												
SCFM	4500	5000	5500	6000	6500	7000	7500	8000	8500	9000	9500	10000
(In WG)	0.15	0.18	0.22	0.27	0.32	0.37	0.42	0.48	0.55	0.61	0.69	0.76

Electrical Data

MODEL NUMBER	ELECTRICAL RATING	COMPRESSOR			OUTDOOR FAN MOTOR			INDOOR FAN MOTOR			OPTIONAL ELECTRIC HEAT			OPTIONAL POWERED CONVENIENCE OUTLET	OPTIONAL POWER EXHAUST	OPTIONAL POWER EXHAUST (MODULATING)	POWER SUPPLY			
		QTY	RLA	LRA	QTY	HP	FLA	QTY	HP	FLA	PART #	KW*	FLA	FLA	FLA	FLA	MCA	MOP		
DSC1803D	208/230/3/60	2	25.0	179	3	0.33	2.0	2	3.5	10.9	-	-	-	-	-	84.1/84.1	100/100			
											-	-	-	-	4.8	-	88.9/88.9	110/110		
											-	-	-	-	-	13.9	98.0/98.0	110/110		
											-	-	-	9.6/8.7	-	-	93.7/92.8	110/110		
											-	-	-	9.6/8.7	4.8	-	98.5/97.6	110/110		
											-	-	-	9.6/8.7	-	13.9	108/107	125/125		
											EH**-3L30	21.6/28.8	60.0/69.3	-	-	-	-	-	102/114	110/125
														-	-	4.8	-	108/120	110/125	
														-	-	-	13.9	120/131	125/150	
														9.6/8.7	-	-	114/125	125/125		
														9.6/8.7	4.8	-	120/131	125/150		
														9.6/8.7	-	13.9	132/142	150/150		
											EH**-3L45	32.4/43.2	90.1/104	-	-	-	-	-	140/157	150/175
														-	-	4.8	-	146/163	150/175	
														-	-	-	13.9	157/175	175/175	
														9.6/8.7	-	-	152/168	175/175		
														9.6/8.7	4.8	-	158/174	175/175		
														9.6/8.7	-	13.9	169/185	175/200		
											EH**-3L60	43.3/57.6	120/139	-	-	-	-	-	177/166	200/175
														-	-	4.8	-	183/172	200/175	
														-	-	-	13.9	195/183	200/200	
														9.6/8.7	-	-	189/177	200/200		
														9.6/8.7	4.8	-	195/183	200/200		
														9.6/8.7	-	13.9	207/194	225/200		
DSC1803W	208/230/3/60	2	25.0	179	3	0.33	2.0	2	5.0	14.5	-	-	-	-	-	91.3/91.3	110/110			
											-	-	-	-	4.8	-	96.1/96.1	110/110		
											-	-	-	-	-	13.9	105/105	125/125		
											-	-	-	9.6/8.7	-	-	101/100	125/125		
											-	-	-	9.6/8.7	4.8	-	106/105	125/125		
											-	-	-	9.6/8.7	-	13.9	115/114	125/125		
											EH**-3L30	21.6/28.8	60.0/69.3	-	-	-	-	-	111/123	125/125
														-	-	4.8	-	117/129	125/150	
														-	-	-	13.9	129/140	150/150	
														9.6/8.7	-	-	123/134	125/150		
														9.6/8.7	4.8	-	129/140	150/150		
														9.6/8.7	-	13.9	141/151	150/175		
											EH**-3L45	32.4/43.2	90.1/104	-	-	-	-	-	149/166	150/175
														-	-	4.8	-	155/172	175/175	
														-	-	-	13.9	166/184	175/200	
														9.6/8.7	-	-	161/177	175/200		
														9.6/8.7	4.8	-	167/183	175/200		
														9.6/8.7	-	13.9	178/194	200/200		
											EH**-3L60	43.3/57.6	120/139	-	-	-	-	-	186/175	200/175
														-	-	4.8	-	192/181	200/200	
														-	-	-	13.9	204/192	225/200	
														9.6/8.7	-	-	198/186	200/200		
														9.6/8.7	4.8	-	204/192	225/200		
														9.6/8.7	-	13.9	216/203	225/225		

Electrical Data

MODEL NUMBER	ELECTRICAL RATING	COMPRESSOR			OUTDOOR FAN MOTOR			INDOOR FAN MOTOR			OPTIONAL ELECTRIC HEAT			OPTIONAL POWERED CONVENIENCE OUTLET	OPTIONAL POWER EXHAUST	OPTIONAL POWER EXHAUST (MODULATING)	POWER SUPPLY	
		QTY	RLA	LRA	QTY	HP	FLA	QTY	HP	FLA	PART #	KW*	FLA	FLA	FLA	FLA	MCA	MOP
DSC1804D	460/3/60	2	10.9	103	3	0.33	0.85	2	3.5	7.2	-	-	-	-	-	41.4	50	
											-	-	-	-	2.4	-	43.8	50
											-	-	-	-	-	8.1	49.5	60
											-	-	-	4.3	-	-	45.7	50
											-	-	-	4.3	2.4	-	48.1	50
											-	-	-	4.3	-	8.1	53.8	60
											EH**-4L30	28.8	34.6	-	-	-	61.3	70
														-	2.4	-	64.3	70
														-	-	8.1	71.4	80
														4.3	-	-	66.7	70
														4.3	2.4	-	69.7	70
											EH**-4L45	43.2	52.0	-	-	-	83.0	90
														-	2.4	-	86.0	90
														-	-	8.1	93.1	100
														4.3	-	-	88.3	90
														4.3	2.4	-	91.3	100
											EH**-4L60	57.6	69.3	-	-	-	87.3	90
														-	2.4	-	90.3	100
														-	-	8.1	97.4	100
														4.3	-	-	92.7	100
														4.3	2.4	-	95.7	100
DSC1804W	460/3/60	2	10.9	103	3	0.33	0.85	2	5.0	10.6	-	-	-	-	-	48.2	50	
											-	-	-	-	2.4	-	50.6	60
											-	-	-	-	-	8.1	56.3	60
											-	-	-	4.3	-	-	52.5	60
											-	-	-	4.3	2.4	-	54.9	60
											-	-	-	4.3	-	8.1	60.6	70
											EH**-4L30	28.8	34.6	-	-	-	69.8	70
														-	2.4	-	72.8	80
														-	-	8.1	79.9	80
														4.3	-	-	75.2	80
														4.3	2.4	-	78.2	80
											EH**-4L45	43.2	52.0	-	-	-	91.5	100
														-	2.4	-	94.5	100
														-	-	8.1	102	110
														4.3	-	-	96.8	100
														4.3	2.4	-	99.8	100
											EH**-4L60	57.6	69.3	-	-	-	95.8	100
														-	2.4	-	98.8	100
														-	-	8.1	106	110
														4.3	-	-	101	110
														4.3	2.4	-	104	110
4.3	-	8.1	111	125														

Electrical Data

MODEL NUMBER	ELECTRICAL RATING	COMPRESSOR			OUTDOOR FAN MOTOR			INDOOR FAN MOTOR			OPTIONAL ELECTRIC HEAT			OPTIONAL POWERED CONVIENIENCE OUTLET	OPTIONAL POWER EXHAUST	OPTIONAL POWER EXHAUST (MODULATING)	POWER SUPPLY	
		QTY	RLA	LRA	QTY	HP	FLA	QTY	HP	FLA	PART #	KW*	FLA	FLA	FLA	FLA	MCA	MOP
DSC1807D	575/3/60	2	8.4	78.0	3	0.33	0.67	2	3.5	5.0	-	-	-	-	-	31.0	35	
											-	-	-	-	2.0	-	33.0	40
											-	-	-	-	-	8.3	39.3	45
											-	-	-	3.5	-	-	34.5	40
											-	-	-	3.5	2.0	-	36.5	40
											-	-	-	3.5	-	8.3	42.8	50
											EH**-7L30	28.8	27.7	-	-	-	47.1	50
														-	2.0	-	49.6	50
														-	-	8.3	57.5	60
														3.5	-	-	51.5	60
														3.5	2.0	-	54.0	60
											EH**-7L45	43.2	41.6	-	-	-	64.5	70
														-	2.0	-	67.0	70
														-	-	8.3	74.8	80
														3.5	-	-	68.8	70
														3.5	2.0	-	71.3	80
											EH**-7L60	57.6	55.4	-	-	-	67.9	70
														-	2.0	-	70.4	80
														-	-	8.3	78.3	80
														3.5	-	-	72.3	80
														3.5	2.0	-	74.8	80
-	-	-	8.3	82.7	90													
DSC1807W	575/3/60	2	8.4	78.0	3	0.33	0.67	2	5.0	7.2	-	-	-	-	-	35.4	40	
											-	-	-	-	2.0	-	37.4	45
											-	-	-	-	-	8.3	43.7	50
											-	-	-	3.5	-	-	38.9	45
											-	-	-	3.5	2.0	-	40.9	45
											-	-	-	3.5	-	8.3	47.2	50
											EH**-7L30	28.8	27.7	-	-	-	52.6	60
														-	2.0	-	55.1	60
														-	-	8.3	63.0	70
														3.5	-	-	57.0	60
														3.5	2.0	-	59.5	60
											EH**-7L45	43.2	41.6	-	-	-	67.4	70
														-	2.0	-	70.0	70
														-	-	8.3	72.5	80
														3.5	-	-	80.3	90
														3.5	2.0	-	74.3	80
											EH**-7L60	57.6	55.4	-	-	-	76.8	80
														-	2.0	-	84.7	90
														-	-	8.3	73.4	80
														3.5	-	-	75.9	80
														3.5	2.0	-	83.8	90
-	-	-	8.3	88.2	90													

Electrical Data

MODEL NUMBER	ELECTRICAL RATING	COMPRESSOR			OUTDOOR FAN MOTOR			INDOOR FAN MOTOR			OPTIONAL ELECTRIC HEAT			OPTIONAL POWERED CONVENIENCE OUTLET	OPTIONAL POWER EXHAUST	OPTIONAL POWER EXHAUST (MODULATING)	POWER SUPPLY			
		QTY	RLA	LRA	QTY	HP	FLA	QTY	HP	FLA	PART #	KW*	FLA	FLA	FLA	FLA	MCA	MOP		
DSC2403D	208/230/3/60	2	29.4	225	4	0.5	2.7	2	3.5	10.9	-	-	-	-	-	98.7/98.7	125/125			
											-	-	-	-	4.8	-	103/103	125/125		
											-	-	-	-	-	13.9	113/113	125/125		
											-	-	-	9.6/8.7	-	-	108/107	125/125		
											-	-	-	9.6/8.7	4.8	-	113/112	125/125		
											-	-	-	9.6/8.7	-	13.9	122/121	150/150		
											EH**-3L30	21.6/28.8	60.0/69.3	-	-	-	-	-	102/114	125/125
														-	4.8	-	-	108/120	125/125	
														-	-	13.9	-	120/131	125/150	
														9.6/8.7	-	-	114/125	125/125		
														9.6/8.7	4.8	-	120/131	125/150		
														9.6/8.7	-	13.9	132/142	150/150		
											EH**-3L45	32.4/43.2	90.1/104	-	-	-	-	-	140/157	150/175
														-	4.8	-	-	146/163	150/175	
														-	-	13.9	-	157/175	175/175	
														9.6/8.7	-	-	152/168	175/175		
														9.6/8.7	4.8	-	158/174	175/175		
														9.6/8.7	-	13.9	169/185	175/200		
											EH**-3L60	43.3/57.6	120/139	-	-	-	-	-	177/166	200/175
														-	4.8	-	-	183/172	200/175	
														-	-	13.9	-	195/183	200/200	
														9.6/8.7	-	-	189/177	200/200		
														9.6/8.7	4.8	-	195/183	200/200		
														9.6/8.7	-	13.9	207/194	225/200		
EH**-3L75	54.1/72.0	150/173	-	-	-	-	-	177/200	200/225											
			-	4.8	-	-	183/206	200/225												
			-	-	13.9	-	195/218	200/225												
			9.6/8.7	-	-	189/211	200/225													
			9.6/8.7	4.8	-	195/217	200/225													
			9.6/8.7	-	13.9	207/229	225/250													
DSC2403W	208/230/3/60	2	29.4	225	4	0.5	2.7	2	5.0	14.5	-	-	-	-	-	106/106	125/125			
											-	-	-	-	4.8	-	111/111	125/125		
											-	-	-	-	-	13.9	120/120	125/125		
											-	-	-	9.6/8.7	-	-	115/115	125/125		
											-	-	-	9.6/8.7	4.8	-	120/119	125/125		
											-	-	-	9.6/8.7	-	13.9	129/128	150/150		
											EH**-3L30	21.6/28.8	60.0/69.3	-	-	-	-	-	111/123	125/125
														-	4.8	-	-	117/129	125/150	
														-	-	13.9	-	129/140	150/150	
														9.6/8.7	-	-	123/134	125/150		
														9.6/8.7	4.8	-	129/140	150/150		
														9.6/8.7	-	13.9	141/151	150/175		
											EH**-3L45	32.4/43.2	90.1/104	-	-	-	-	-	149/166	150/175
														-	4.8	-	-	155/172	175/175	
														-	-	13.9	-	166/184	175/200	
														9.6/8.7	-	-	161/177	175/200		
														9.6/8.7	4.8	-	167/183	175/200		
														9.6/8.7	-	13.9	178/194	200/200		
											EH**-3L60	43.3/57.6	120/139	-	-	-	-	-	186/175	200/175
														-	4.8	-	-	192/181	200/200	
														-	-	13.9	-	204/192	225/200	
														9.6/8.7	-	-	198/186	200/200		
														9.6/8.7	4.8	-	204/192	225/200		
														9.6/8.7	-	13.9	216/203	225/225		
EH**-3L75	54.1/72.0	150/173	-	-	-	-	-	186/209	200/225											
			-	4.8	-	-	192/215	200/225												
			-	-	13.9	-	204/227	225/250												
			9.6/8.7	-	-	198/220	200/225													
			9.6/8.7	4.8	-	204/226	225/250													
			9.6/8.7	-	13.9	216/238	225/250													

Electrical Data

MODEL NUMBER	ELECTRICAL RATING	COMPRESSOR			OUTDOOR FAN MOTOR			INDOOR FAN MOTOR			OPTIONAL ELECTRIC HEAT			OPTIONAL POWERED CONVENIENCE OUTLET	OPTIONAL POWER EXHAUST	OPTIONAL POWER EXHAUST (MODULATING)	POWER SUPPLY	
		QTY	RLA	LRA	QTY	HP	FLA	QTY	HP	FLA	PART #	KW*	FLA	FLA	FLA	FLA	MCA	MOP
DSC2404D	460/3/60	2	13.7	130	4	0.5	1.4	2	3.5	7.2	-	-	-	-	-	50.8	60	
											-	-	-	-	2.4	-	53.2	60
											-	-	-	-	-	8.1	58.9	70
											-	-	-	4.3	-	-	55.1	60
											-	-	-	4.3	2.4	-	57.5	70
											-	-	-	4.3	-	8.1	63.2	70
											EH**-4L30	28.8	34.6	-	-	-	61.3	70
														-	2.4	-	64.3	70
														-	-	8.1	71.4	80
														4.3	-	-	66.7	70
														4.3	2.4	-	69.7	70
														4.3	-	8.1	76.8	80
											EH**-4L45	43.2	52.0	-	-	-	83.0	90
														-	2.4	-	86.0	90
														-	-	8.1	93.1	100
														4.3	-	-	88.3	90
														4.3	2.4	-	91.3	100
														4.3	-	8.1	98.5	100
											EH**-4L60	57.6	69.3	-	-	-	87.3	90
														-	2.4	-	90.3	100
														-	-	8.1	97.4	100
														4.3	-	-	92.7	100
														4.3	2.4	-	95.7	100
														4.3	-	8.1	103	110
EH**-4L75	72.0	86.6	-	-	-	105	110											
			-	2.4	-	108	110											
			-	-	8.1	115	125											
			4.3	-	-	110	110											
			4.3	2.4	-	113	125											
			4.3	-	8.1	120	125											
DSC2404W	460/3/60	2	13.7	130	4	0.5	1.4	2	5.0	10.6	-	-	-	-	-	57.6	70	
											-	-	-	-	2.4	-	60.0	70
											-	-	-	-	-	8.1	65.7	70
											-	-	-	4.3	-	-	61.9	70
											-	-	-	4.3	2.4	-	64.3	70
											-	-	-	4.3	-	8.1	70.0	80
											EH**-4L30	28.8	34.6	-	-	-	69.8	70
														-	2.4	-	72.8	80
														-	-	8.1	79.9	80
														4.3	-	-	75.2	80
														4.3	2.4	-	78.2	80
														4.3	-	8.1	85.3	90
											EH**-4L45	43.2	52.0	-	-	-	91.5	100
														-	2.4	-	94.5	100
														-	-	8.1	102	110
														4.3	-	-	96.8	100
														4.3	2.4	-	99.8	100
														4.3	-	8.1	107	110
											EH**-4L60	57.6	69.3	-	-	-	95.8	100
														-	2.4	-	98.8	100
														-	-	8.1	106	110
														4.3	-	-	101	110
														4.3	2.4	-	104	110
														4.3	-	8.1	111	125
EH**-4L75	72.0	86.6	-	-	-	113	125											
			-	2.4	-	116	125											
			-	-	8.1	123	125											
			4.3	-	-	118	125											
			4.3	2.4	-	121	125											
			4.3	-	8.1	129	150											

Electrical Data

MODEL NUMBER	ELECTRICAL RATING	COMPRESSOR			OUTDOOR FAN MOTOR			INDOOR FAN MOTOR			OPTIONAL ELECTRIC HEAT			OPTIONAL POWERED CONVENIENCE OUTLET	OPTIONAL POWER EXHAUST	OPTIONAL POWER EXHAUST (MODULATING)	POWER SUPPLY		
		QTY	RLA	LRA	QTY	HP	FLA	QTY	HP	FLA	PART #	KW*	FLA	FLA	FLA	FLA	MCA	MOP	
DSC2407D	575/3/60	2	10.9	93.7	4	0.5	1.0	2	3.5	5.0	-	-	-	-	-	38.5	45		
											-	-	-	-	2.0	-	40.5	50	
											-	-	-	-	-	-	8.3	46.8	50
											-	-	-	3.5	-	-	42.0	50	
											-	-	-	3.5	2.0	-	44.0	50	
											-	-	-	3.5	-	-	50.3	60	
											EH**-7L30	28.8	27.7	-	-	-	47.1	50	
														-	2.0	-	49.6	50	
														-	-	8.3	57.5	60	
														3.5	-	-	51.5	60	
														3.5	2.0	-	54.0	60	
											EH**-7L45	43.2	41.6	-	-	-	61.9	70	
														-	2.0	-	64.5	70	
														-	-	8.3	67.0	70	
														3.5	-	-	74.8	80	
														3.5	2.0	-	68.8	70	
											EH**-7L60	57.6	55.4	-	-	-	71.3	80	
														-	2.0	-	79.2	80	
														-	-	8.3	78.3	80	
														3.5	-	-	72.3	80	
														3.5	2.0	-	74.8	80	
											EH**-7L75	72.0	69.3	-	-	-	82.7	90	
														-	2.0	-	81.8	90	
														-	-	8.3	92.2	100	
3.5	-	-	86.2	90															
3.5	2.0	-	88.7	90															
DSC2407W	575/3/60	2	10.9	93.7	4	0.5	1.0	2	5.0	7.2	-	-	-	-	-	42.9	50		
											-	-	-	-	2.0	-	44.9	50	
											-	-	-	-	-	-	8.3	51.2	60
											-	-	-	3.5	-	-	46.4	50	
											-	-	-	3.5	2.0	-	48.4	50	
											-	-	-	3.5	-	-	54.7	60	
											EH**-7L30	28.8	27.7	-	-	-	52.6	60	
														-	2.0	-	55.1	60	
														-	-	8.3	63.0	70	
														3.5	-	-	57.0	60	
														3.5	2.0	-	59.5	60	
											EH**-7L45	43.2	41.6	-	-	-	67.4	70	
														-	2.0	-	70.0	70	
														-	-	8.3	72.5	80	
														3.5	-	-	80.3	90	
														3.5	2.0	-	74.3	80	
											EH**-7L60	57.6	55.4	-	-	-	76.8	80	
														-	2.0	-	84.7	90	
														-	-	8.3	73.4	80	
														3.5	-	-	75.9	80	
														3.5	2.0	-	83.8	90	
											EH**-7L75	72.0	69.3	-	-	-	80.3	90	
														-	2.0	-	88.2	90	
														-	-	8.3	87.3	90	
3.5	-	-	89.8	90															
3.5	2.0	-	97.7	100															
-	-	-	91.7	100															
-	-	-	94.2	100															
-	-	-	102	110															

Electrical Data

MODEL NUMBER	ELECTRICAL RATING	COMPRESSOR			OUTDOOR FAN MOTOR			INDOOR FAN MOTOR			OPTIONAL ELECTRIC HEAT			OPTIONAL POWERED CONVENIENCE OUTLET	OPTIONAL POWER EXHAUST	OPTIONAL POWER EXHAUST (MODULATING)	POWER SUPPLY		
		QTY	RLA	LRA	QTY	HP	FLA	QTY	HP	FLA	PART #	KW*	FLA	FLA	FLA	FLA	MCA	MOP	
DSC3003D	208/230/3/60	2	35.3	270	5	0.5	2.7	2	5.0	14.5	-	-	-	-	-	122/122	150/150		
											-	-	-	-	4.8	-	127/127	150/150	
											-	-	-	-	-	13.9	136/136	150/150	
											-	-	-	9.6/8.7	-	-	131/131	150/150	
											-	-	-	9.6/8.7	4.8	-	136/135	150/150	
											-	-	-	9.6/8.7	-	13.9	145/144	175/175	
											EH**-3L30	21.6/28.8	60.0/69.3	-	-	-	-	122/123	150/150
														-	4.8	-	127/129	150/150	
														-	-	13.9	136/140	150/150	
														9.6/8.7	-	-	131/134	150/150	
														9.6/8.7	4.8	-	136/140	150/150	
											9.6/8.7	-	13.9	145/151	175/175				
											EH**-3L45	32.4/43.2	90.1/104	-	-	-	-	149/166	150/175
														-	4.8	-	155/172	175/175	
														-	-	13.9	166/184	175/200	
														9.6/8.7	-	-	161/177	175/200	
														9.6/8.7	4.8	-	167/183	175/200	
											9.6/8.7	-	13.9	178/194	200/200				
											EH**-3L60	43.3/57.6	120/139	-	-	-	-	186/175	200/175
														-	4.8	-	192/181	200/200	
														-	-	13.9	204/192	225/200	
														9.6/8.7	-	-	198/186	200/200	
														9.6/8.7	4.8	-	204/192	225/200	
											9.6/8.7	-	13.9	216/203	225/225				
EH**-3L75	54.1/72.0	150/173	-	-	-	-	186/209	200/225											
			-	4.8	-	192/215	200/225												
			-	-	13.9	204/227	225/250												
			9.6/8.7	-	-	198/220	200/225												
			9.6/8.7	4.8	-	204/226	225/250												
9.6/8.7	-	13.9	216/238	225/250															
DSC3003W	208/230/3/60	2	35.3	270	5	0.5	2.7	2	5.0	14.5	-	-	-	-	-	122/122	150/150		
											-	-	-	-	4.8	-	127/127	150/150	
											-	-	-	-	-	13.9	136/136	150/150	
											-	-	-	9.6/8.7	-	-	131/131	150/150	
											-	-	-	9.6/8.7	4.8	-	136/135	150/150	
											-	-	-	9.6/8.7	-	13.9	145/144	175/175	
											EH**-3L30	21.6/28.8	60.0/69.3	-	-	-	-	122/123	150/150
														-	4.8	-	127/129	150/150	
														-	-	13.9	136/140	150/150	
														9.6/8.7	-	-	131/134	150/150	
														9.6/8.7	4.8	-	136/140	150/150	
											9.6/8.7	-	13.9	145/151	175/175				
											EH**-3L45	32.4/43.2	90.1/104	-	-	-	-	149/166	150/175
														-	4.8	-	155/172	175/175	
														-	-	13.9	166/184	175/200	
														9.6/8.7	-	-	161/177	175/200	
														9.6/8.7	4.8	-	167/183	175/200	
											9.6/8.7	-	13.9	178/194	200/200				
											EH**-3L60	43.3/57.6	120/139	-	-	-	-	186/175	200/175
														-	4.8	-	192/181	200/200	
														-	-	13.9	204/192	225/200	
														9.6/8.7	-	-	198/186	200/200	
														9.6/8.7	4.8	-	204/192	225/200	
											9.6/8.7	-	13.9	216/203	225/225				
EH**-3L75	54.1/72.0	150/173	-	-	-	-	186/209	200/225											
			-	4.8	-	192/215	200/225												
			-	-	13.9	204/227	225/250												
			9.6/8.7	-	-	198/220	200/225												
			9.6/8.7	4.8	-	204/226	225/250												
9.6/8.7	-	13.9	216/238	225/250															

Electrical Data

MODEL NUMBER	ELECTRICAL RATING	COMPRESSOR			OUTDOOR FAN MOTOR			INDOOR FAN MOTOR			OPTIONAL ELECTRIC HEAT			OPTIONAL POWERED CONVENIENCE OUTLET	OPTIONAL POWER EXHAUST	OPTIONAL POWER EXHAUST (MODULATING)	POWER SUPPLY								
		QTY	RLA	LRA	QTY	HP	FLA	QTY	HP	FLA	PART #	KW*	FLA	FLA	FLA	FLA	FLA	MCA	MOP						
DSC3004D	460/3/60	2	20.5	147	5	0.5	1.4	2	5.0	10.6	-	-	-	-	-	-	74.3	90							
											-	-	-	-	-	-	-	2.4	-	76.7	90				
											-	-	-	-	-	-	-	-	-	8.1	-	82.4	100		
											-	-	-	-	-	-	-	4.3	-	-	-	78.6	90		
											-	-	-	-	-	-	-	4.3	2.4	-	-	81.0	100		
											-	-	-	-	-	-	-	4.3	-	-	8.1	86.7	100		
											EH**-4L30	28.8	34.6	-	-	-	-	-	-	-	-	-	74.3	90	
														-	-	-	-	-	-	-	2.4	-	76.7	90	
														-	-	-	-	-	-	-	-	-	8.1	82.4	100
														4.3	-	-	-	-	-	-	-	-	78.6	90	
														4.3	2.4	-	-	-	-	-	-	-	81.0	100	
														4.3	-	-	-	-	-	-	-	8.1	86.7	100	
											EH**-4L45	43.2	52.0	-	-	-	-	-	-	-	-	-	91.5	100	
														-	-	-	-	-	-	-	2.4	-	94.5	100	
														-	-	-	-	-	-	-	-	-	8.1	102	110
														4.3	-	-	-	-	-	-	-	-	96.8	100	
														4.3	2.4	-	-	-	-	-	-	-	99.8	100	
														4.3	-	-	-	-	-	-	-	8.1	107	110	
											EH**-4L60	57.6	69.3	-	-	-	-	-	-	-	-	-	95.8	100	
														-	-	-	-	-	-	-	2.4	-	98.8	100	
														-	-	-	-	-	-	-	-	-	8.1	106	110
														4.3	-	-	-	-	-	-	-	-	101	110	
														4.3	2.4	-	-	-	-	-	-	-	104	110	
														4.3	-	-	-	-	-	-	-	8.1	111	125	
EH**-4L75	72.0	86.6	-	-	-	-	-	-	-	-	-	113	125												
			-	-	-	-	-	-	-	2.4	-	116	125												
			-	-	-	-	-	-	-	-	-	8.1	123	125											
			4.3	-	-	-	-	-	-	-	-	118	125												
			4.3	2.4	-	-	-	-	-	-	-	121	125												
			4.3	-	-	-	-	-	-	-	8.1	129	150												
DSC3004W	460/3/60	2	20.5	147	5	0.5	1.4	2	5.0	10.6	-	-	-	-	-	-	74.3	90							
											-	-	-	-	-	-	-	2.4	-	76.7	90				
											-	-	-	-	-	-	-	-	-	8.1	-	82.4	100		
											-	-	-	-	-	-	-	4.3	-	-	-	78.6	90		
											-	-	-	-	-	-	-	4.3	2.4	-	-	81.0	100		
											-	-	-	-	-	-	-	4.3	-	-	8.1	86.7	100		
											EH**-4L30	28.8	34.6	-	-	-	-	-	-	-	-	-	74.3	90	
														-	-	-	-	-	-	-	2.4	-	76.7	90	
														-	-	-	-	-	-	-	-	-	8.1	82.4	100
														4.3	-	-	-	-	-	-	-	-	78.6	90	
														4.3	2.4	-	-	-	-	-	-	-	81.0	100	
														4.3	-	-	-	-	-	-	-	8.1	86.7	100	
											EH**-4L45	43.2	52.0	-	-	-	-	-	-	-	-	-	91.5	100	
														-	-	-	-	-	-	-	2.4	-	94.5	100	
														-	-	-	-	-	-	-	-	-	8.1	102	110
														4.3	-	-	-	-	-	-	-	-	96.8	100	
														4.3	2.4	-	-	-	-	-	-	-	99.8	100	
														4.3	-	-	-	-	-	-	-	8.1	107	110	
											EH**-4L60	57.6	69.3	-	-	-	-	-	-	-	-	-	95.8	100	
														-	-	-	-	-	-	-	2.4	-	98.8	100	
														-	-	-	-	-	-	-	-	-	8.1	106	110
														4.3	-	-	-	-	-	-	-	-	101	110	
														4.3	2.4	-	-	-	-	-	-	-	104	110	
														4.3	-	-	-	-	-	-	-	8.1	111	125	
EH**-4L75	72.0	86.6	-	-	-	-	-	-	-	-	-	113	125												
			-	-	-	-	-	-	-	2.4	-	116	125												
			-	-	-	-	-	-	-	-	-	8.1	123	125											
			4.3	-	-	-	-	-	-	-	-	118	125												
			4.3	2.4	-	-	-	-	-	-	-	121	125												
			4.3	-	-	-	-	-	-	-	8.1	129	150												

Electrical Data

MODEL NUMBER	ELECTRICAL RATING	COMPRESSOR			OUTDOOR FAN MOTOR			INDOOR FAN MOTOR			OPTIONAL ELECTRIC HEAT			OPTIONAL POWERED CONVENIENCE OUTLET	OPTIONAL POWER EXHAUST	OPTIONAL POWER EXHAUST (MODULATING)	POWER SUPPLY	
		QTY	RLA	LRA	QTY	HP	FLA	QTY	HP	FLA	PART #	KW*	FLA	FLA	FLA	FLA	MCA	MOP
DSC3007D	575/3/60	2	13.8	109	5	0.5	1.0	2	5.0	7.2	-	-	-	-	-	50.4	60	
											-	-	-	-	2.0	-	52.4	60
											-	-	-	-	-	8.3	58.7	70
											-	-	-	3.5	-	-	53.9	60
											-	-	-	3.5	2.0	-	55.9	60
											-	-	-	3.5	-	8.3	62.2	70
											EH**-7L30	28.8	27.7	-	-	-	52.6	60
														-	2.0	-	55.1	60
														-	-	8.3	63.0	70
														3.5	-	-	57.0	60
														3.5	2.0	-	59.5	60
														3.5	-	8.3	67.4	70
											EH**-7L45	43.2	41.6	-	-	-	70.0	70
														-	2.0	-	72.5	80
														-	-	8.3	80.3	90
														3.5	-	-	74.3	80
														3.5	2.0	-	76.8	80
														3.5	-	8.3	84.7	90
											EH**-7L60	57.6	55.4	-	-	-	73.4	80
														-	2.0	-	75.9	80
														-	-	8.3	83.8	90
														3.5	-	-	77.8	80
														3.5	2.0	-	80.3	90
														3.5	-	8.3	88.2	90
EH**-7L75	72.0	69.3	-	-	-	87.3	90											
			-	2.0	-	89.8	90											
			-	-	8.3	97.7	100											
			3.5	-	-	91.7	100											
			3.5	2.0	-	94.2	100											
			3.5	-	8.3	102	110											
DSC3007W	575/3/60	2	13.8	109	5	0.5	1.0	2	5.0	7.2	-	-	-	-	-	50.4	60	
											-	-	-	-	2.0	-	52.4	60
											-	-	-	-	-	8.3	58.7	70
											-	-	-	3.5	-	-	53.9	60
											-	-	-	3.5	2.0	-	55.9	60
											-	-	-	3.5	-	8.3	62.2	70
											EH**-7L30	28.8	27.7	-	-	-	52.6	60
														-	2.0	-	55.1	60
														-	-	8.3	63.0	70
														3.5	-	-	57.0	60
														3.5	2.0	-	59.5	60
														3.5	-	8.3	67.4	70
											EH**-7L45	43.2	41.6	-	-	-	70.0	70
														-	2.0	-	72.5	80
														-	-	8.3	80.3	90
														3.5	-	-	74.3	80
														3.5	2.0	-	76.8	80
														3.5	-	8.3	84.7	90
											EH**-7L60	57.6	55.4	-	-	-	73.4	80
														-	2.0	-	75.9	80
														-	-	8.3	83.8	90
														3.5	-	-	77.8	80
														3.5	2.0	-	80.3	90
														3.5	-	8.3	88.2	90
EH**-7L75	72.0	69.3	-	-	-	87.3	90											
			-	2.0	-	89.8	90											
			-	-	8.3	97.7	100											
			3.5	-	-	91.7	100											
			3.5	2.0	-	94.2	100											
			3.5	-	8.3	102	110											

AIR FLOW FOR ELECTRIC HEAT					
UNIT	HEATER KIT MODEL NUMBER	KW	STAGES	MINIMUM CFM	MAXIMUM CFM
15 ton AC STD Static	EH*-*L30	30	2	6000	8000
	EH*-*L45	45			
	EH*-*L60	60			
15 ton AC High Static	EH*-*L30	30	2	5250	9500
	EH*-*L45	45			
	EH*-*L60	60			
20 ton AC STD Static	EH*-*L30	30	2	7000	9400
	EH*-*L45	45			
	EH*-*L60	60			
	EH*-*L75	75			
20 ton AC High Static	EH*-*L30	30	2	7000	10300
	EH*-*L45	45			
	EH*-*L60	60			
	EH*-*L75	75			
25 ton AC STD Static	EH*-*L30	30	2	8750	11000
	EH*-*L45	45			
	EH*-*L60	60			
	EH*-*L75	75			
25 ton AC High Static	EH*-*L30	30	2	7500	11700
	EH*-*L45	45			
	EH*-*L60	60			
	EH*-*L75	75			

HEATER KIT MODEL NUMBER NOMENCLATURE

	E	H	X	-	3	L	30
	1	2	3	-	4	5	6,7
Electric							
Heater							
Heater Type							
X							
S							
Voltage							
3							
4							
7							
Chassis							
L							
Kilowatt							
30							
45							
60							
75							

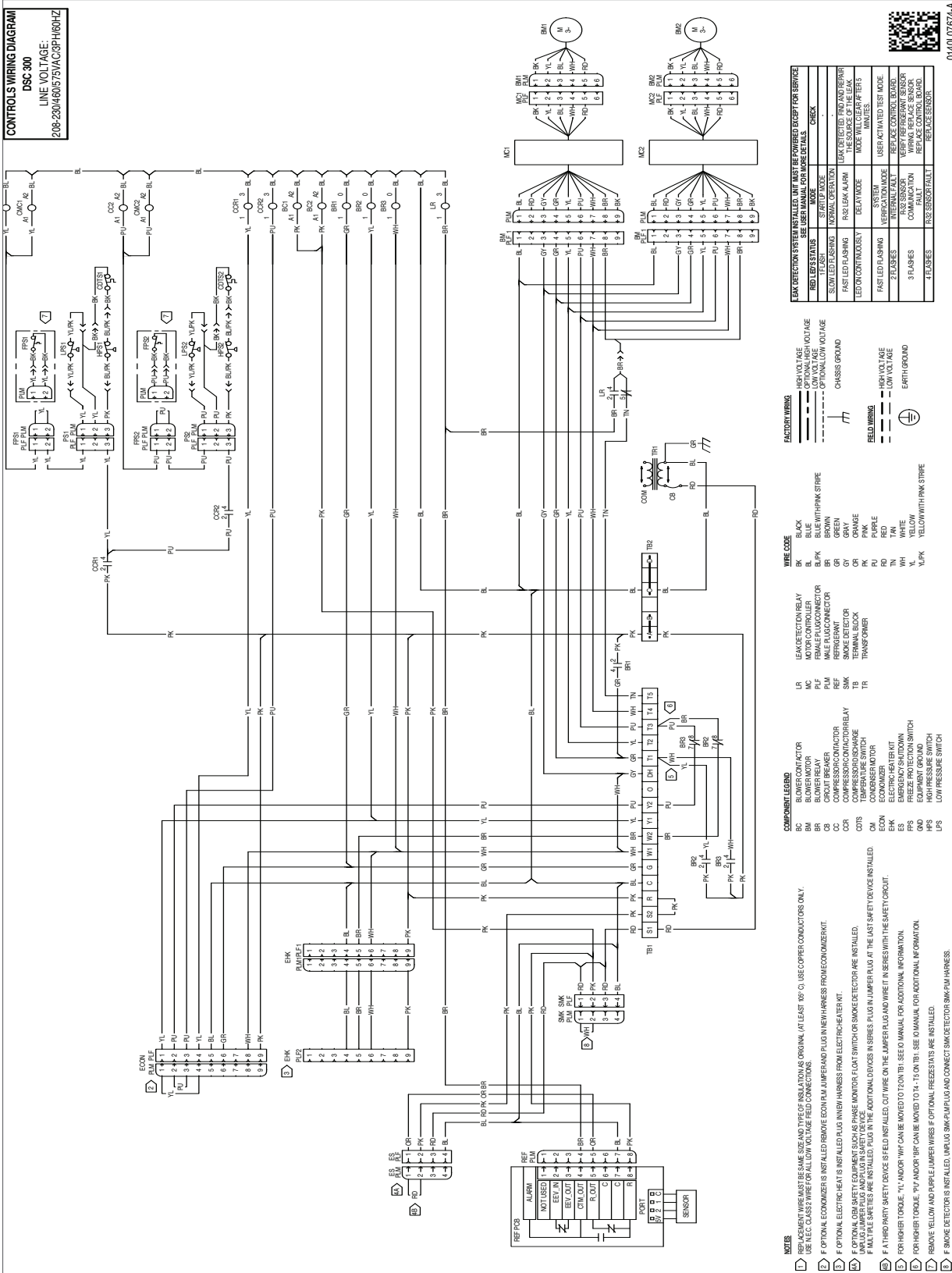

WARNING
 High Voltage: Disconnect all power before servicing or installing this unit. Multiple power sources may be present. Failure to do so may cause property damage, personal injury, or death.

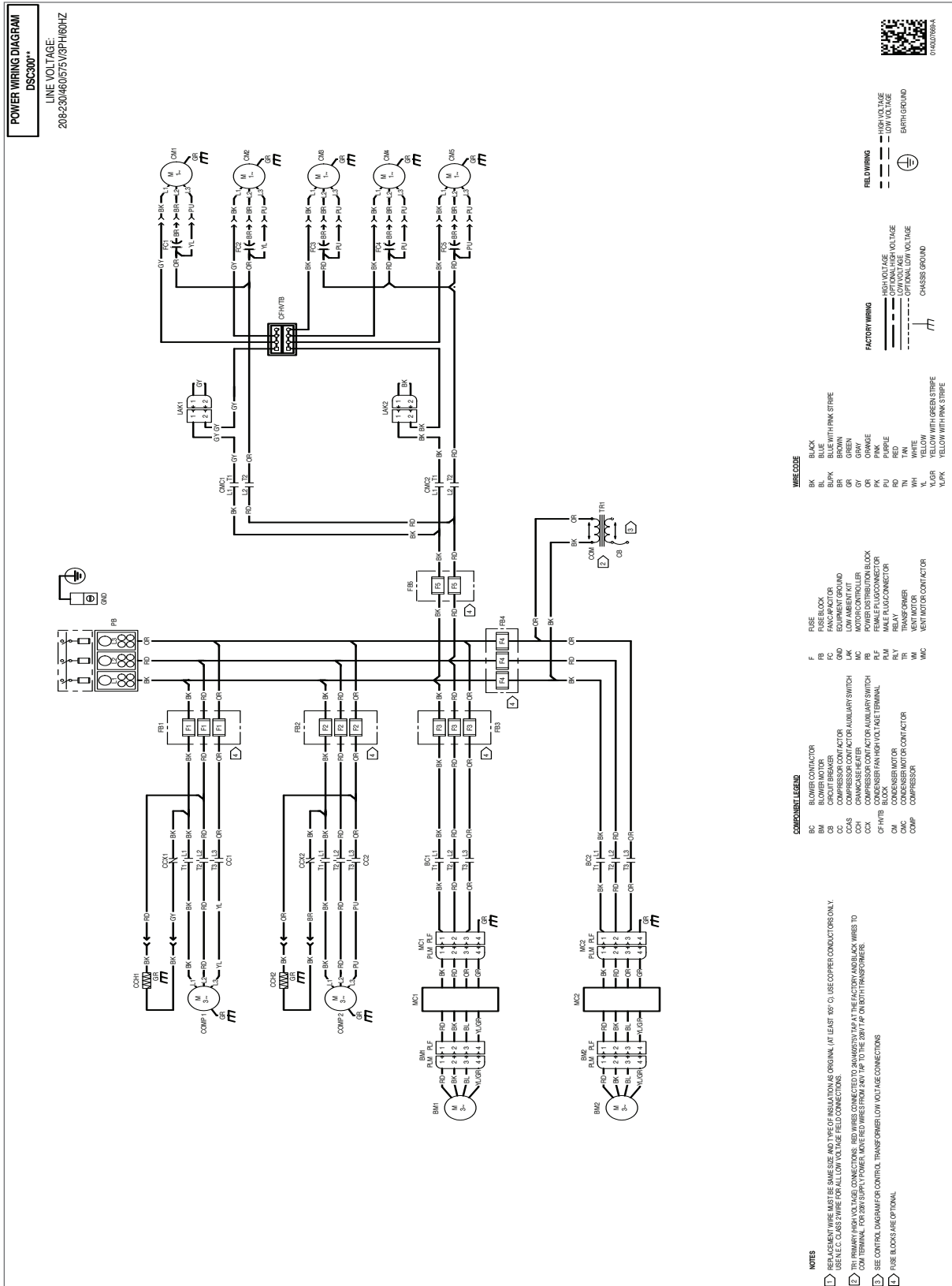

WARNING

High Voltage: Disconnect all power before servicing or installing this unit. Multiple power sources may be present. Failure to do so may cause property damage, personal injury, or death.

Wiring is subject to change. Always refer to the wiring diagram on the unit for the most up-to-date wiring.

POWER WIRING DIAGRAM
DSC180 DDC
 LINE VOLTAGE:
 208-230/460/575V/3PH/60HZ

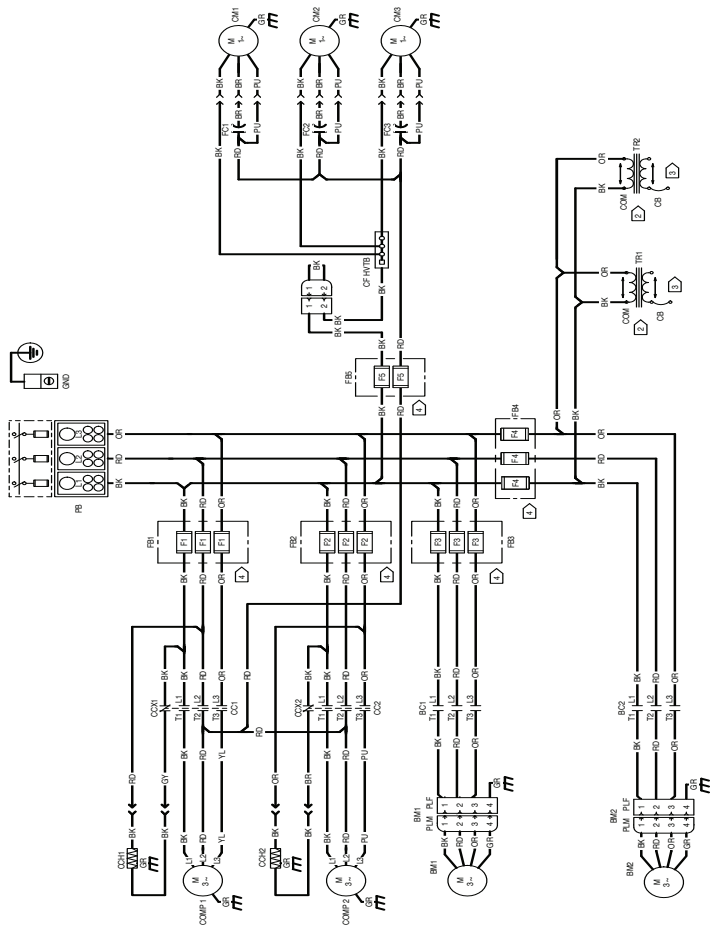

- NOTES**
- ▷ RE-LOCATED WIRE MUST BE SAME SIZE AND TYPE OF INSULATION AS ORIGINAL (AT LEAST 10°C). USE COPPER CONDUCTORS ONLY.
 - ▷ TIGHTEN TERMINALS AND WIRE CONNECTIONS. ORANGE WIRES ARE USED FOR 480V/3W/3P AT THE FACTORY AND BLACK WIRES TO COMB TERMINAL FOR 208V SUPPLY POWER. MOVE ORANGE WIRES FROM 2W/1P TO THE 208V TAP.
 - ▷ SEE CONTROL DIAGRAM FOR CONTROL TRANSFORMER LOW VOLTAGE CONNECTIONS
 - ▷ OPTIONAL FACTORY INSTALLED EQUIPMENT

- COMPONENT LEGEND**
- FC FAN CAPACITOR
 - EQD EQUIPMENT GROUND
 - PF FEMALE PLUG CONNECTOR
 - TR TRANSFORMER
 - CF HVTB COMPRESSOR CONTACTOR AUXILIARY SWITCH
 - OM CONDENSER FAN HIGH VOLTAGE TERMINAL
 - COMP COMPRESSOR
 - F FUSE
 - FB FUSE BLOCK

- WIRE CODE**
- BL BLACK
 - BLU BLUE
 - BLK WITH PINK STRIPE BLUE WITH PINK STRIPE
 - BLRK BLURK
 - GR GREEN
 - GY GRAY
 - OR ORANGE
 - PV PURPLE
 - RED RED
 - TN TAN
 - WHT WHITE
 - YL YELLOW
 - YL/PK YELLOW WITH PINK STRIPE

- FACTORY WIRING**
- HIGH VOLTAGE
 - OPTIMAL HIGH VOLTAGE
 - LOW VOLTAGE
 - OPTIMAL LOW VOLTAGE
 - CF FAN LOW VOLTAGE
 - CHASSIS GROUND
- FIELD WIRING**
- HIGH VOLTAGE
 - LOW VOLTAGE
 - EARTH GROUND



01602709A

WARNING

High Voltage: Disconnect all power before servicing or installing this unit. Multiple power sources may be present. Failure to do so may cause property damage, personal injury, or death.

Wiring is subject to change. Always refer to the wiring diagram on the unit for the most up-to-date wiring.

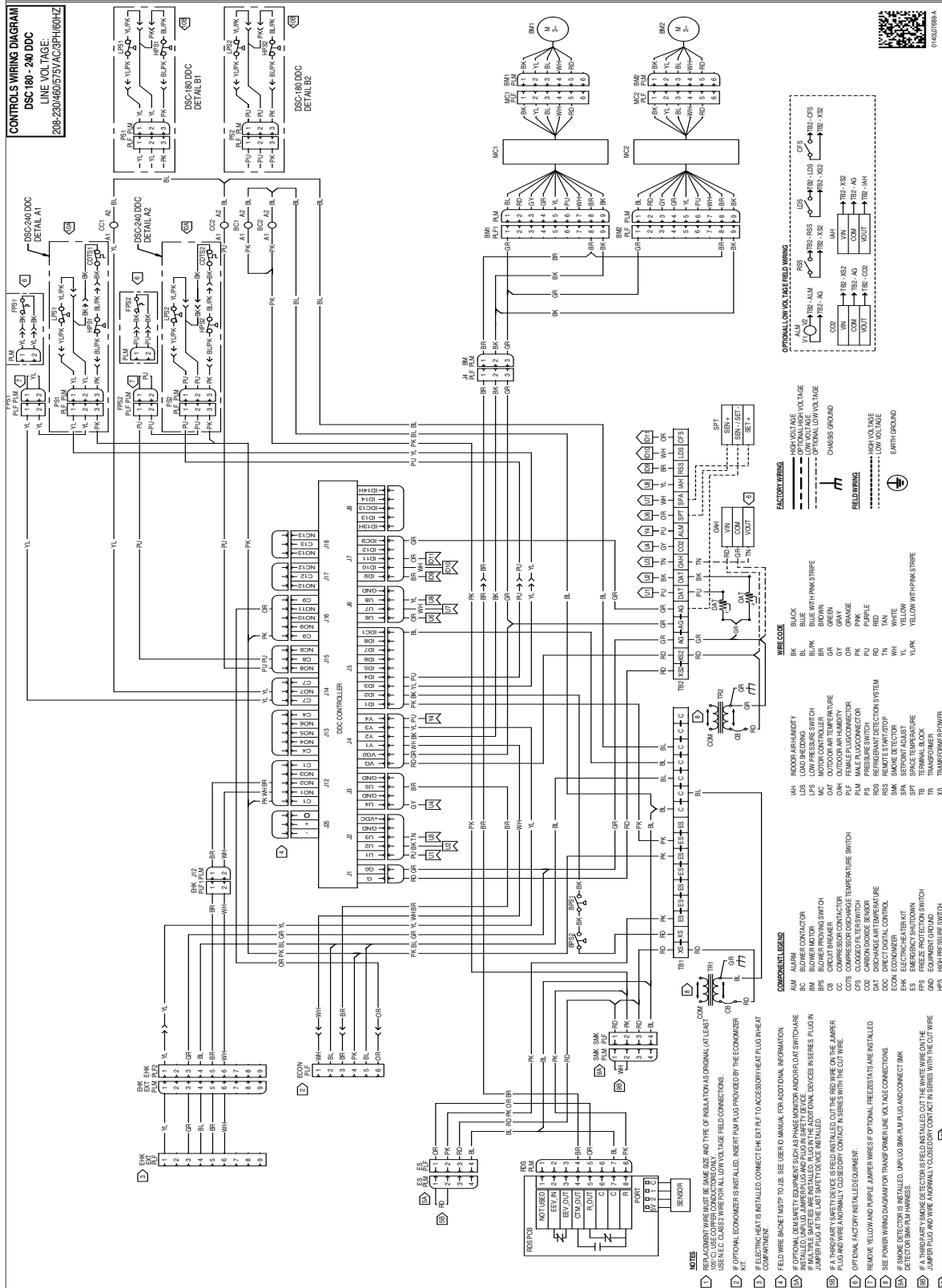

WARNING

High Voltage: Disconnect all power before servicing or installing this unit. Multiple power sources may be present. Failure to do so may cause property damage, personal injury, or death.

Wiring is subject to change. Always refer to the wiring diagram on the unit for the most up-to-date wiring.

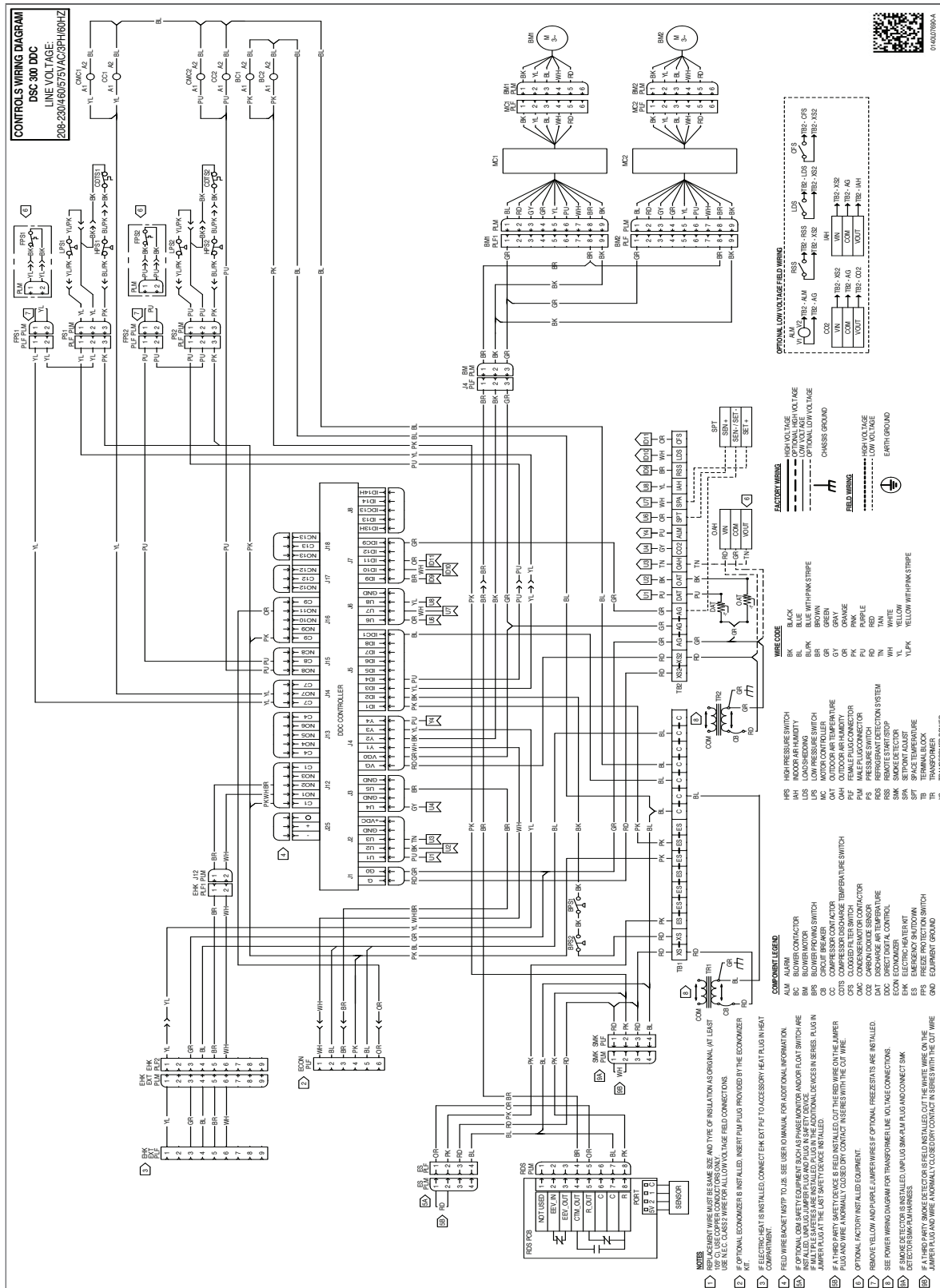

WARNING
 High Voltage: Disconnect all power before servicing or installing this unit. Multiple power sources may be present. Failure to do so may cause property damage, personal injury, or death.

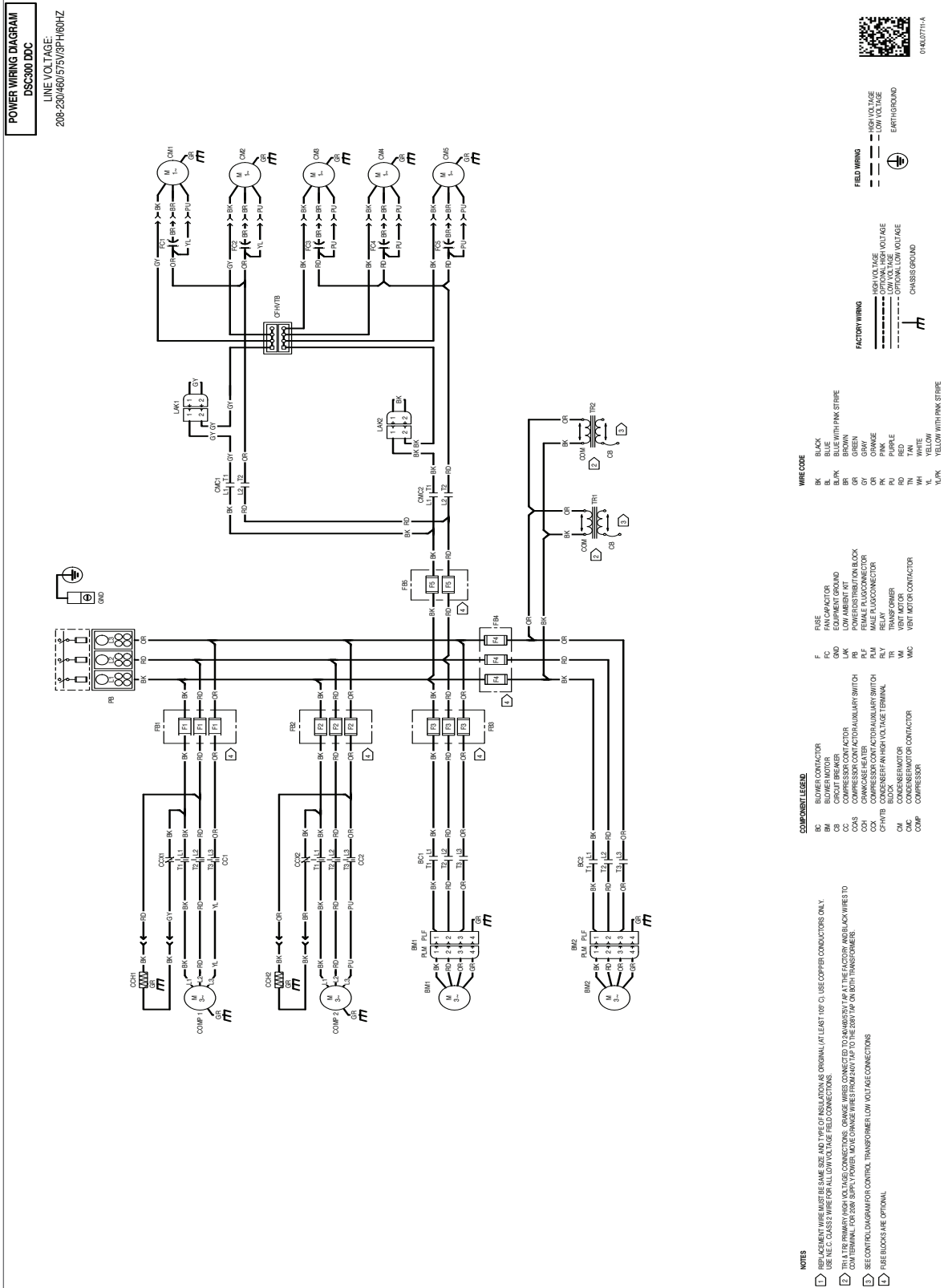

WARNING

High Voltage: Disconnect all power before servicing or installing this unit. Multiple power sources may be present. Failure to do so may cause property damage, personal injury, or death.

Wiring is subject to change. Always refer to the wiring diagram on the unit for the most up-to-date wiring.

Unit Clearances

Electrical Entrance Locations

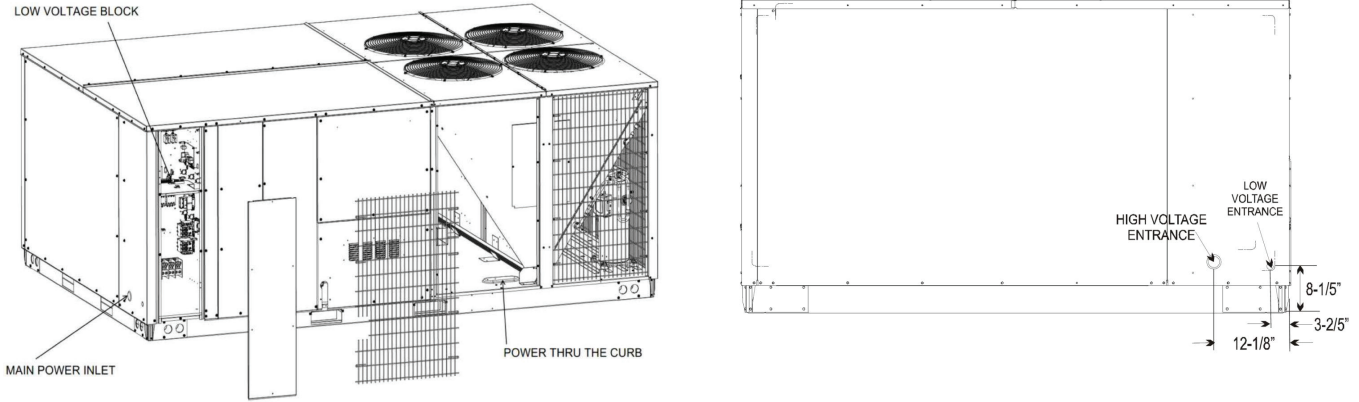

Service Clearance

Allow for recommended service clearances as shown in the image below. In situations that have multiple units, a 36" minimum clearance is required between the condenser coils. A clearance of 48" is recommended on all sides of the unit to allow service access and to ensure proper ventilation and condenser airflow. The top of the unit should be unobstructed. Provide a roof walkway along the sides of the unit for service and access to controls and components. Contact your Daikin sales representative for service requirements less than those recommended.

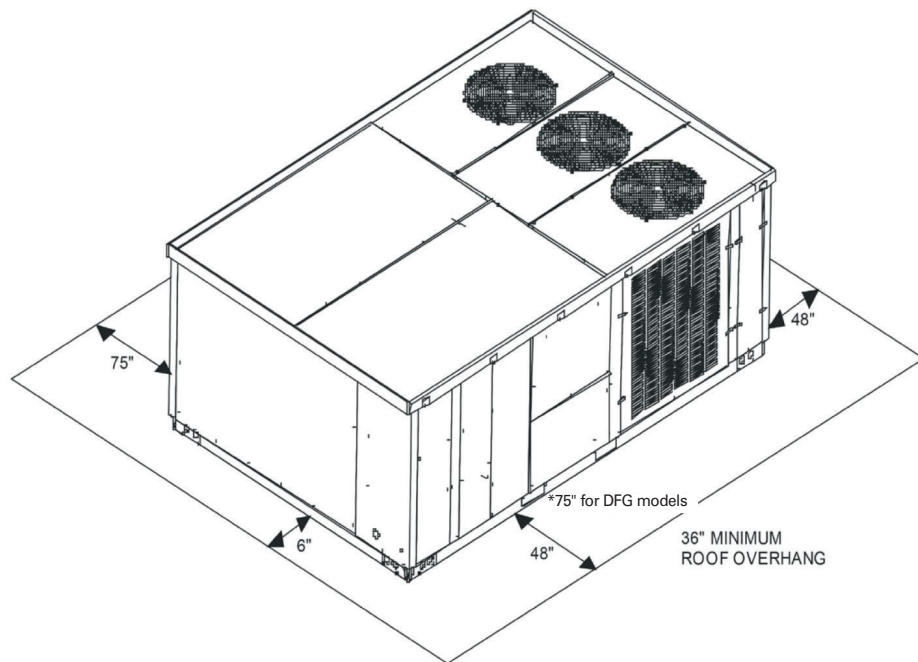

Installation

Unit Location

The structural engineer must verify that the roof has adequate support and ability to minimize deflection. Take extreme caution when using on a wooden roof structure. Unit condenser coils should be in a location that avoids any heated exhaust air.

Allow sufficient space around the unit for maintenance/service clearance. Consult your Daikin sales representative if available clearances do not meet minimum recommendations.

Where code considerations, such as the NEC, require extended clearances, these take precedence.

Provisions for forks have been included in the unit base frame. No other fork locations are approved.

- » Unit must be lifted by the four lifting holes located at the base frame corners.
- » Lifting cables should be attached to the unit with shackles.
- » The distance between the crane hook and the top of the unit must not be less than 60".
- » Two spreader bars must span over the unit to prevent damage to the cabinet by the lift cables. Spreader bars must be of sufficient length so that cables do not come in contact with the unit during transport. Remove wood struts mounted beneath unit base frame before setting unit on roof curb. These struts are intended to protect unit base frame from forklift damage. To remove the struts, extract the sheet metal retainers and pull the struts through the base of the unit. Refer to rigging label on the unit.

Important: If using bottom discharge with roof curb, duct-work should be attached to the curb prior to installing the unit. Refer to the Roof Curb Installation Instructions for proper curb installation. Curbing must be installed in compliance with the National Roofing Contractors Association Manual. Lower unit carefully onto roof mounting curb. While rigging the unit, the center of gravity will cause the condenser end to be lower than the supply air end. Bring condenser end of unit into alignment with the curb. With condenser end of the unit resting on curb member and using curb as a fulcrum, lower opposite end of the unit until entire unit is seated on the curb. When a rectangular cantilever curb is used, take care to center the unit. Check for proper alignment and orientation of supply and return openings with duct. For further and more detailed information please refer to our Daikin Light Commercial Packaged unit IOD.

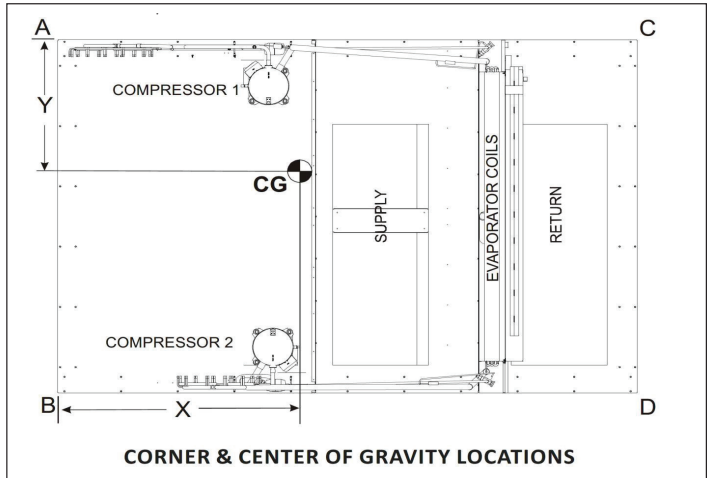
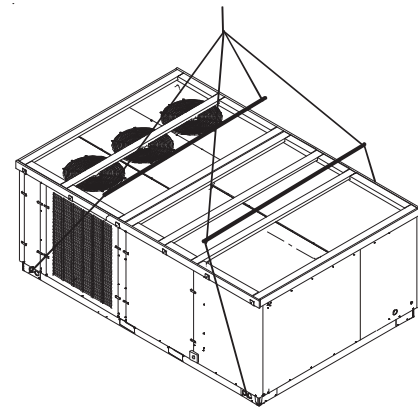

Roof Curb Installation

The roof curb is field-assembled and must be installed level (within 1/16" per foot side to side). A sub-base must be constructed by the contractor in applications involving pitched roofs. Gaskets are furnished and must be installed between the unit and curb. For proper installation, follow NRCA guidelines. In applications requiring post and rail installation, an I-beam securely mounted on multiple posts should support the unit on each side. In addition, the insulation on the underside of the unit should be protected from the elements. Applications in geographic areas subjected to seismic or hurricane conditions must meet code requirements for fastening the unit to the curb and the curb to the building structure.

Weights

MODEL	SHIPPING WEIGHT (LBS)	¼OPERATING WEIGHT (LBS)	CORNER WEIGHTS (LBS)				LENGTH X (in)	WIDTH Y (in)
			A	B	C	D		
DSC1803D000001S	1851	1736	510	377	374	475	65½	45⅝
DSC1804D000001S	1851	1736	510	377	374	475	65½	45⅝
DSC1807D000001S	1851	1736	510	377	374	475	65½	45⅝
DSC2403D000001S	2204	2089	651	498	377	563	60¾	48¾
DSC2404D000001S	2204	2089	651	498	377	563	60¾	48¾
DSC2407D000001S	2204	2089	651	498	377	563	60¾	48¾
DSC3003D000001S	2244	2129	651	501	440	538	61½	45⅝
DSC3004D000001S	2244	2129	651	501	440	538	61½	45⅝
DSC3007D000001S	2244	2129	651	501	440	538	61½	45⅝

For details on accessories refer to document **PM-LC-ACCESSORIES**